

A N A L Y S E N T E C H N I K



MERCK MILLIPORE

HPLC-Säulen & Materialien

Stand 1.3.2015

Entwicklung • Herstellung
Vertrieb • Beratung

2015

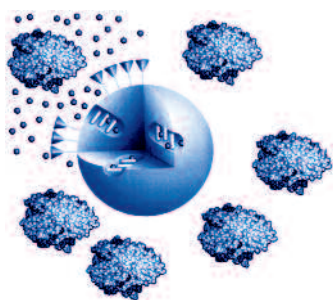

Chromolith®

ChiraDex®

ChiraSep®

Purospher®

Superspher®

LiChrospher® ADS

Aluspher®

LiChrosil®

LiChrogel® PS

Purospher® STAR

LiChrospher®

HitHunter®

LiChrosorb®

Chiraspher®

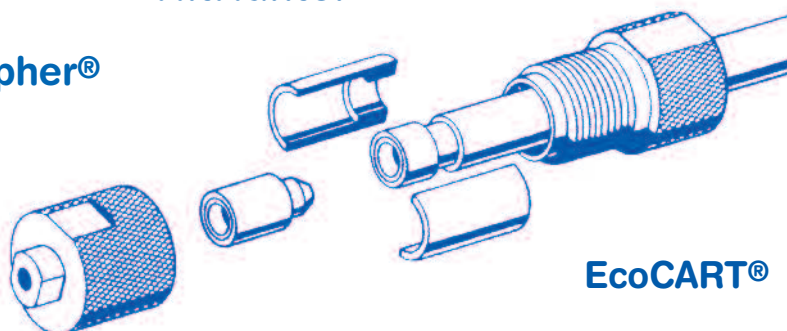

EcoCART®

Hibar®

MicroCART®

ManuCART®

LiChroCART®

Hibar® RT

HPLC-Säulen

- Neu + Refill
- umfangreiche Auswahl an Packungsmaterialien
- micro • analytisch • präparativ
- PerfectChrom • PerfectBond
- MZ-AquaPerfect • PerfectSil
- PerfectSil Target • Orbit

Vertriebspartner für:

- GRACEVYDAC • GL-SCIENCES
- THERMO SCIENTIFIC • MERCK
- Eka-Nobel/KROMASIL • IMTAKT
- Agilent • DAICEL / CHROMTECH
- ES-INDUSTRIES • AMT/HALO
- ACE • SEPAX TECHNOLOGIES
- MACHEREY-NAGEL • HICHROM

MZ-PAH

- Trennung von PAK's

MZ-PBM

- Trennung von Pestiziden

MZ-Gel SD^{plus}

- GPC-Säulen Organisch
- Styrol-Divinylbenzol

MZ-Gel Super FG

- GPC mit fluorierten Eluentien

Zubehör

- RHEODYNE-Ventile
- EXMIRE-Spritzen
- Spritzenfilter
- Vorsäulensysteme
- Kapillaren
- Verschraubungen uvm.

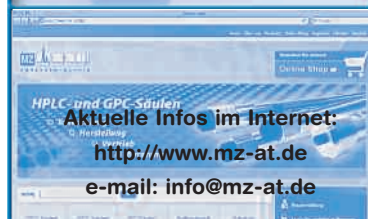

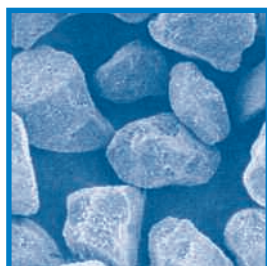

Lichrosorb®

- Seit vielen Jahren bewährt
- Total porös
- Gebrochene Teilchen
- Fein klassiert
- Viele Modifizierungen
- Kontrollierte Belegung

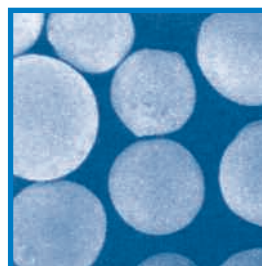

Lichrospher®

- Total porös
- Teilchengröße: 5 & 10 µm
- Porenweiten: 6, 10 & 30 nm
- Feinklassiert
- Viele Modifizierungen
- Kontrollierte Belegung

Bulkmaterialien

Lichrosorb®

Best.-Nr.	Beschreibung	Menge	€
1.09309.0010	10 µm Si 100	10 g	95,00
1.09318.0010	10 µm RP-8	10 g	439,00
1.09318.0100	10 µm RP-8	100 g	3.220,20
1.09333.0010	5 µm RP-18	10 g	480,00
1.09334.0010	10 µm RP-18	10 g	545,00

Bulkmaterialien

Lichrospher®

Best.-Nr.	Beschreibung	Menge	€
1.19640.0010	5 µm Si 60	10 g	261,00
1.19640.0100	5 µm Si 60	100 g	☎
1.19641.0010	5 µm 60 RP-select B	10 g	895,00
1.19642.0010	10 µm 60 RP-select B	10 g	796,00
1.16129.0010	5 µm 100 RP-8	10 g	675,00
1.16139.0010	10 µm 100 RP-8	10 g	698,00
1.19636.0010	5 µm 100 RP-8 endcapped	10 g	699,00
1.19632.0010	10 µm 100 RP-8 endcapped	10 g	699,00
1.16177.0010	5 µm 100 RP-18	10 g	698,00
1.16105.0010	10 µm 100 RP-18	10 g	698,00
1.19637.0010	5 µm 100 RP-18 endcapped	10 g	699,00
1.19637.0100	5 µm 100 RP-18 endcapped	100 g	4.980,00
1.19633.0010	10 µm 100 RP-18 endcapped	10 g	699,00
1.19633.0100	10 µm 100 RP-18 endcapped	100 g	4.540,00
1.16178.0010	5 µm 100 NH2	10 g	698,00
1.19638.0010	5 µm 100 CN	10 g	699,00
1.19631.0010	10 µm 100 CN	10 g	646,00
1.16152.0010	5 µm 100 DIOL	10 g	698,00

Bulkmaterialien

Superspher®

Best.-Nr.	Beschreibung	Menge	€
1.19612.0010	4 µm 60 RP-8	10 g	816,00
1.19617.0100	4 µm 60 RP-8 endcapped	100 g	☎
1.19613.0010	4 µm 100 RP-18	10 g	816,00
1.19618.0010	4 µm 100 RP-18 endcapped	10 g	816,00
1.19643.0010	4 µm 60 RP-select B	10 g	1.040,00

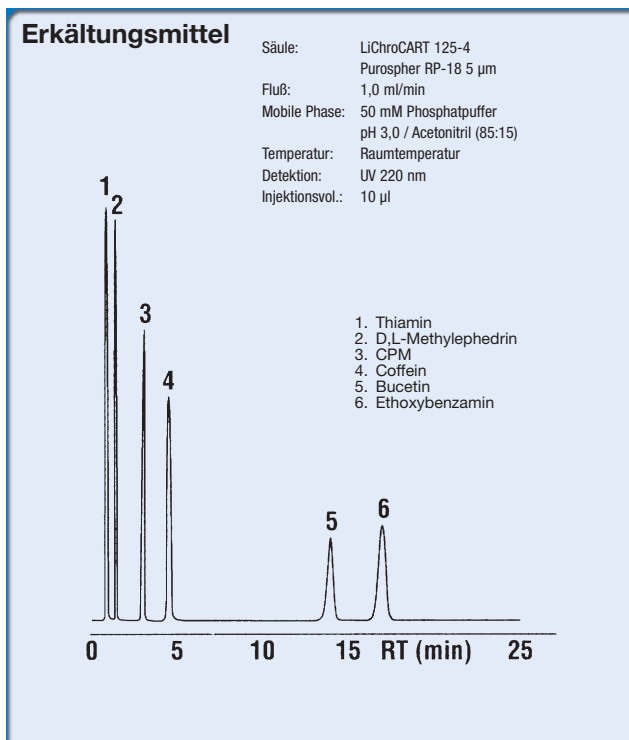

LiChrospher ADS®

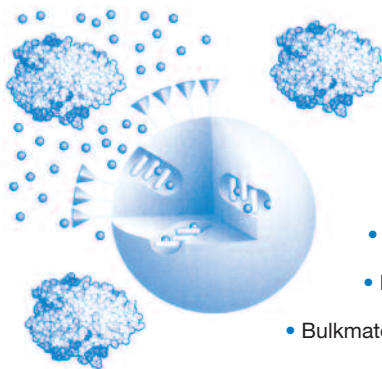

- Hoher Probendurchsatz
- Hohe Reproduzierbarkeit
- Niedrige Kosten pro Probe
- Restricted Access-Material
- Bulkmaterial mit C18-Modifizierung
- LC-integrierte Probenaufbereitung möglich
- Direkte Injektion unbehandelter biologischer Flüssigkeiten

Bulkmaterialien

LiChrospher ADS

Best.-Nr.	Beschreibung	Menge	€
1.50347.0010	RP18 ADS 25 µm <i>für die integrierte Probenaufbereitung</i>	10 g	2.040,00

LiChroCART®

ChiraDex®

Best.-Nr.	Beschreibung	€
1.50201.7004	10 x 2 mm 5 µm 100 LiChroCART 3 Stk.	☎
1.50229.7004	30 x 2 mm 5 µm 100 LiChroCART	☎
1.50234.7004	55 x 2 mm 5 µm 100 LiChroCART	☎
1.50195.7004	125 x 2 mm 5 µm 100 LiChroCART	☎
1.50190.7004	250 x 2 mm 5 µm 100 LiChroCART	☎
1.50233.7004	30 x 3 mm 5 µm 100 LiChroCART	☎
1.50236.7004	55 x 3 mm 5 µm 100 LiChroCART	☎
1.50175.7004	125 x 3 mm 5 µm 100 LiChroCART	☎
1.50177.7004	250 x 3 mm 5 µm 100 LiChroCART	☎
1.50117.0001	4 x 4 mm 5 µm 100 Vorsäule 10 Stk.	248,00
1.50302.7004	30 x 4 mm 5 µm 100 LiChroCART	☎
1.50228.7004	55 x 4 mm 5 µm 100 LiChroCART	☎
1.50171.7004	75 x 4 mm 5 µm 100 LiChroCART	☎
1.50170.7004	125 x 4 mm 5 µm 100 LiChroCART	☎
1.51000.0001	250 x 4 mm 5 µm High Resolution Kit	952,00
1.51333.0001	250 x 4 mm 5 µm 100 Kartusche	952,00
1.51448.7004	100 x 4,6 mm 5 µm 100 LiChroCART	☎
1.51442.7004	125 x 4,6 mm 5 µm 100 LiChroCART	☎
1.51432.7004	150 x 4,6 mm 5 µm 100 LiChroCART	☎
1.51431.7004	250 x 4,6 mm 5 µm 100 LiChroCART	☎

Hibar®

ChiraDex®

Best.-Nr.	Beschreibung	€
1.00423.7004	250 x 3 mm 5 µm 100 Hibar	☎
1.51196.7004	30 x 4 mm 5 µm 100 Hibar	☎
1.50181.7004	125 x 4 mm 5 µm 100 Hibar	☎
1.50182.7004	250 x 4 mm 5 µm 100 Hibar	☎
1.50013.7004	100 x 4,6 mm 5 µm 100 Hibar	☎
1.50012.7004	125 x 4,6 mm 5 µm 100 Hibar	☎
1.50009.7004	150 x 4,6 mm 5 µm 100 Hibar	☎
1.00424.7004	250 x 4,6 mm 5 µm 100 Hibar	☎

Methadon

Säule: LiChroCART 250-4
 ChiraDex
 Fluß: 0,8 ml/min
 Mobile Phase: Triethylammoniumacetat-Lösung
 (1 % pH 4,1/Acetonitril 98/2 (v/v))
 Detektion: UV 254 nm

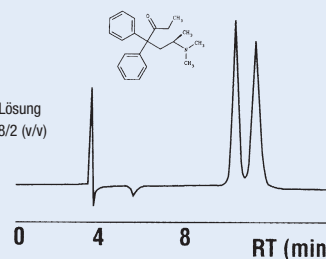

Hibar/LiChroCART

Chiraspher 100 NT

Best.-Nr.	Beschreibung	€
1.00423.7006	250 x 3 mm 5 µm Hibar	☎
1.51196.7006	30 x 4 mm 5 µm Hibar	☎
1.50182.7006	250 x 4 mm 5 µm Hibar	☎
1.50181.7006	125 x 4 mm 5 µm Hibar	☎
1.50013.7006	100 x 4,6 mm 5 µm Hibar	☎
1.50012.7006	125 x 4,6 mm 5 µm Hibar	☎
1.50009.7006	150 x 4,6 mm 5 µm Hibar	☎
1.00424.7006	250 x 4,6 mm 5 µm Hibar	☎
1.50183.7006	250 x 10 mm 5 µm Hibar	☎
1.50201.7006	10 x 2 mm 5 µm LiChroCART 3 Stk.	☎
1.50229.7006	30 x 2 mm 5 µm LiChroCART	☎
1.50234.7006	55 x 2 mm 5 µm LiChroCART	☎
1.50195.7006	125 x 2 mm 5 µm LiChroCART	☎
1.50190.7006	250 x 2 mm 5 µm LiChroCART	☎
1.50233.7006	30 x 3 mm 5 µm LiChroCART	☎
1.50236.7006	55 x 3 mm 5 µm LiChroCART	☎
1.50175.7006	125 x 3 mm 5 µm LiChroCART	☎
1.50177.7006	250 x 3 mm 5 µm LiChroCART	☎
1.50173.7006	4 x 4 mm 5 µm LiChroCART 10 Stk.	☎
1.50302.7006	30 x 4 mm 5 µm LiChroCART	☎
1.50228.7006	55 x 4 mm 5 µm LiChroCART	☎
1.50171.7006	75 x 4 mm 5 µm LiChroCART	☎
1.50170.7006	125 x 4 mm 5 µm LiChroCART	☎
1.51448.7006	100 x 4,6 mm 5 µm LiChroCART	☎
1.51442.7006	125 x 4,6 mm 5 µm LiChroCART	☎
1.51432.7006	150 x 4,6 mm 5 µm LiChroCART	☎
1.51431.7006	250 x 4,6 mm 5 µm LiChroCART	☎
1.50178.7006	10 x 10 mm 5 µm LiChroCART	☎
1.51446.7006	50 x 10 mm 5 µm LiChroCART	☎
1.51449.7006	75 x 10 mm 5 µm LiChroCART	☎
1.51445.7006	100 x 10 mm 5 µm LiChroCART	☎
1.51443.7006	125 x 10 mm 5 µm LiChroCART	☎
1.51444.7006	150 x 10 mm 5 µm LiChroCART	☎
1.50179.7006	250 x 10 mm 5 µm LiChroCART	☎

Hibar/LiChroCART

Chirasep 100 DNBPG

Best.-Nr.	Beschreibung	€
1.00423.7005	250 x 3 mm 5 µm Hibar	☎
1.51196.7005	30 x 4 mm 5 µm Hibar	☎
1.50181.7005	125 x 4 mm 5 µm Hibar	☎
1.50182.7005	250 x 4 mm 5 µm Hibar	☎
1.50013.7005	100 x 4,6 mm 5 µm Hibar	☎
1.50012.7005	125 x 4,6 mm 5 µm Hibar	☎
1.50009.7005	150 x 4,6 mm 5 µm Hibar	☎
1.00424.7005	250 x 4,6 mm 5 µm Hibar	☎
1.50183.7005	250 x 10 mm 5 µm Hibar	☎
1.50201.7005	10 x 2 mm 5 µm LiChroCART 3 Stk.	☎
1.50229.7005	30 x 2 mm 5 µm LiChroCART	☎
1.50234.7005	55 x 2 mm 5 µm LiChroCART	☎
1.50195.7005	125 x 2 mm 5 µm LiChroCART	☎
1.50190.7005	250 x 2 mm 5 µm LiChroCART	☎
1.50236.7005	55 x 3 mm 5 µm LiChroCART	☎
1.50233.7005	30 x 3 mm 5 µm LiChroCART	☎
1.50175.7005	125 x 3 mm 5 µm LiChroCART	☎
1.50177.7005	250 x 3 mm 5 µm LiChroCART	☎
1.50302.7005	30 x 4 mm 5 µm LiChroCART	☎
1.50228.7005	55 x 4 mm 5 µm LiChroCART	☎
1.50171.7005	75 x 4 mm 5 µm LiChroCART	☎
1.50170.7005	125 x 4 mm 5 µm LiChroCART	☎
1.50174.7005	250 x 4 mm 5 µm LiChroCART	☎
1.51448.7005	100 x 4,6 mm 5 µm LiChroCART	☎
1.51442.7005	125 x 4,6 mm 5 µm LiChroCART	☎
1.51432.7005	150 x 4,6 mm 5 µm LiChroCART	☎
1.51431.7005	250 x 4,6 mm 5 µm LiChroCART	☎
1.50178.7005	10 x 10 mm 5 µm LiChroCART 2 Stk.	☎
1.51446.7005	50 x 10 mm 5 µm LiChroCART	☎
1.51449.7005	75 x 10 mm 5 µm LiChroCART	☎
1.51445.7005	100 x 10 mm 5 µm LiChroCART	☎
1.51443.7005	125 x 10 mm 5 µm LiChroCART	☎
1.51444.7005	150 x 10 mm 5 µm LiChroCART	☎
1.50179.7005	250 x 10 mm 5 µm LiChroCART	☎

LiChrospher ADS®

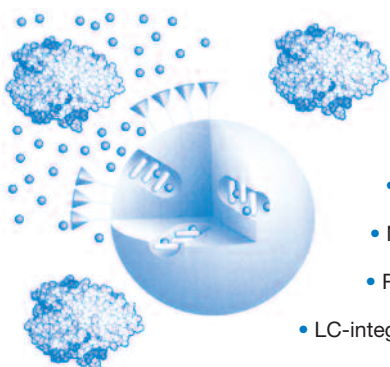

- Hoher Probendurchsatz
- Hohe Reproduzierbarkeit
- Niedrige Kosten pro Probe
- Restricted Access-Material
- LC-integrierte Probenaufbereitung
- Lieferbar mit C4-, C8- sowie C18-Modifizierung
- Direkte Injektion unbehandelter biologischer Flüssigkeiten

LiChroCART® LiChrospher® ADS

Best.-Nr.	Beschreibung	€
1.50210.0001	25 x 4 mm HPLC Selektivitätskit <i>enthält: je 1 LiChroCART 25-4 RP-4 ADS / RP-8 ADS / RP-18 ADS + 1 manu-CART</i>	1.853,00
1.50380.0001	25 x 2 mm RP-4 ADS	460,00
1.50381.0001	25 x 2 mm RP-4 ADS (3 Stk.)	1.242,00
1.50206.0001	25 x 4 mm RP-4 ADS (Satz) <i>enthält: 1 LiChroCART 25-4 RP-4 ADS 1 manu-CART</i>	777,00
1.50208.0001	25 x 4 mm RP-4 ADS (3 Stk.)	1.614,00
1.50382.0001	25 x 2 mm RP-8 ADS	460,00
1.50383.0001	25 x 2 mm RP-8 ADS (3 Stk.)	1.165,00
1.50207.0001	25 x 4 mm RP-8 ADS (Satz) <i>enthält: 1 LiChroCART 25-4 RP-8 ADS 1 manu-CART</i>	777,00
1.50209.0001	25 x 4 mm RP-8 ADS (3 Stk.)	1.614,00
1.50386.0001	25 x 2 mm RP-18 ADS (3 Stk.)	1.279,00
1.50385.0001	25 x 2 mm RP-18 ADS	474,00
1.50187.0001	25 x 4 mm RP-18 ADS (Satz) <i>enthält: 1 LiChroCART 25-4 RP-18 ADS 1 manu-CART</i>	800,00
1.50947.0001	25 x 4 mm RP-18 ADS (3 Stk.)	1.662,00

Edelstahl-Säulen HitHunter®

HitHunter® Purospher®

Best.-Nr.	Beschreibung	€
1.50278.0001	30 x 10 mm 5 µm STAR RP-8 endc.	☎
1.50283.0001	50 x 10 mm 5 µm STAR RP-18 endc.	☎
1.50282.0001	50 x 10 mm 5 µm STAR RP-8 endc.	☎
1.50287.0001	100 x 10 mm 5 µm STAR RP-18 endc.	☎
1.50286.0001	100 x 10 mm 5 µm STAR RP-8 endc.	☎
1.50292.0001	30 x 21,2 mm 5 µm STAR RP-18 endc.	☎
1.50296.0001	50 x 21,2 mm 5 µm STAR RP-18 endc.	☎
1.50295.0001	50 x 21,2 mm 5 µm STAR RP-8 endc.	☎
1.50299.0001	100 x 21,2 mm 5 µm STAR RP-8 endc.	☎
1.50322.0001	30 x 25 mm 5 µm STAR RP-18 endc.	☎
1.50319.0001	30 x 25 mm 5 µm STAR RP-8 endc.	☎
1.50326.0001	50 x 25 mm 5 µm STAR RP-18 endc.	☎
1.50325.0001	50 x 25 mm 5 µm STAR RP-8 endc.	☎

HitHunter® Säulen sind optimiert f. d. kombinatorische Chemie

LiChroCART® Nucleosil®

Best.-Nr.	Beschreibung	€
1.51402.0003	125 x 4 mm 5 µm C8	353,10
1.51387.0003	250 x 4 mm 5 µm C8	☎
1.51377.0003	250 x 4 mm 10 µm C8	☎
1.51324.0003	4 x 4 mm 5 µm C18 (10 Stk.)	☎
1.51329.0003	125 x 4 mm 5 µm C18	☎
1.51388.0003	250 x 4 mm 5 µm C18	☎
1.51378.0003	250 x 4 mm 10 µm C18	☎

HPLC-Fertigsäule RT LiChrosil® CA

Best.-Nr.	Beschreibung	€
1.50160.0001	10 x 4,6 mm LiChrosil IC CA	☎

LiChroCART® Aluspher®

Best.-Nr.	Beschreibung	€
1.51310.0001	4 x 4 mm 5 µm Al 100 (10 Stk.)	308,00
1.51311.0001	4 x 4 mm 5 µm 100 RP-select B (10 Stk.)	☎
1.51315.0001	125 x 4 mm 5 µm 100 RP-select B	604,00
1.51318.0001	250 x 4 mm 5 µm 100 RP-select B	713,00

Glaskartuschen EcoCART®



EcoCART® 125 x 3 mm

Best.-Nr.	Beschreibung	€
1.51233.0001	5 µm LiChrospher 60 RP-select B (3 Stk.)	☎
1.51232.0001	5 µm LiChrospher 100 RP-18 (3 Stk.)	☎
1.51427.0001	5 µm LiChrospher 100 RP-18 endc. (3 Stk.)	☎
1.51425.0001	5 µm Superspher 60 RP-select B	☎
1.51423.0001	5 µm Superspher 100 RP-18 endc.	389,00
1.50180.7130	5 µm Purospher RP-18e	☎
1.50180.7127	5 µm Purospher RP-18	☎
1.50180.7005	5 µm Chirasep 100 DNBPG	☎
1.50180.7004	5 µm ChiraDex 100	☎
1.50180.7006	5 µm Chiraspher 100	☎

EcoCART® Zubehör

Best.-Nr.	Beschreibung	€
1.51207.0001	Halterung f. EcoCART 125-3 <i>1 Einspannrohr, 2 manu-CART '4' Überwurfmuttern, 1 Vorsäulenhalter</i>	☎

Chromolith®

Chromolith® - monolithische HPLC-Fertigsäulen

Best.-Nr.	Beschreibung	€
1.50403.0001	150 x 0,05 mm CapRod RP18e	850,00
1.50426.0001	50 x 0,1 mm CapRod RP18e Trap	260,00
1.50402.0001	150 x 0,1 mm CapRod RP18e	850,00
1.50404.0001	150 x 0,1 mm CapRod RP18e HR	850,00
1.50400.0001	150 x 0,1 mm CapRod RP8e	859,00
1.50409.0001	50 x 0,2 mm CapRod RP18e TRAP	323,30
1.50405.0001	150 x 0,2 mm CapRod RP18e	850,00
1.50407.0001	150 x 0,2 mm CapRod RP18e HR	850,00
1.52008.0001	5 x 2,1 mm RP-18e Vorsäulenkit	350,00
1.52009.0001	5 x 2,1 mm RP-18e Vorsäule 3 Stück	308,00
1.52014.0001	25 x 2,1 mm RP-18e Flash	366,00
1.52007.0001	50 x 2,1 mm RP-18e Fastgradient	604,00
1.52006.0001	100 x 2,1 mm RP-18e	957,00
1.52004.0001	5 x 3,0 mm RP-18e Vorsäulenkit	322,00
1.52005.0001	5 x 3,0 mm RP-18e Vorsäule 3 Stück	252,00
1.52003.0001	25 x 3,0 mm RP-18e Flash	336,00
1.52002.0001	50 x 3,0 mm SpeedROD RP-18e	554,00
1.52001.0001	100 x 3,0 mm RP-18e	877,00
1.51470.0001	5 x 4,6 mm RP-18e Vorsäulenkit	324,00
1.51451.0001	5 x 4,6 mm RP-18e Vorsäule 3 Stück	247,00
1.51471.0001	10 x 4,6 mm RP-18e Vorsäulenkit	358,00
1.51452.0001	10 x 4,6 mm RP-18e Vorsäule 3 Stück	281,00
1.51463.0001	25 x 4,6 mm Flash RP-18e	336,00
1.51450.0001	50 x 4,6 mm SpeedROD RP-18e	504,00
1.02129.0001	100 x 4,6 mm Performance RP-18e	798,00
1.51466.0001	100 x 4,6 mm Validierungskit 3 Stk. RP-18e	2.205,00
1.51465.0001	100 x 4,6 mm Performance Si	718,00
1.51468.0001	100 x 4,6 mm Performance RP-8e	798,00
1.52016.0001	100 x 10 mm Chromolith Semiprep RP-18e	1.595,00
1.25251.0001	100 x 25 mm Chromolith Prep Si	5.220,00
1.25252.0001	100 x 25 mm Chromolith Prep RP-18e	6.380,00

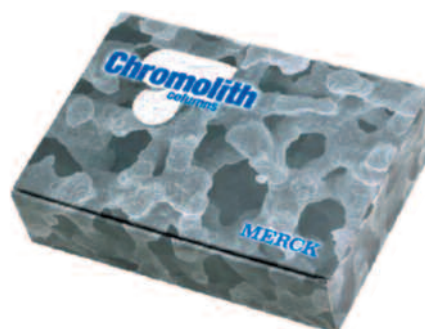

Chromolith® - Zubehör

Best.-Nr.	Beschreibung	€
1.25254.0001	Dichtungset Chromolith prep	174,00
1.25256.0001	Satz Endverschraubungen Chromolith prep	330,00
1.25257.0001	Frittenset Chromolith prep	117,00
1.25255.0001	Werkzeugset Chromolith prep	161,00
1.51467.0001	Kopplungsstück, totvolumenfrei	48,00
1.25259.0001	Chromolith prep Kopplungsstück	1.013,00
1.52037.0001	SemiPrep Halter f. VK 10x10 mm	323,00

Hibar® RT

LiChrogel® PS

Best.-Nr.	Beschreibung	€
1.50056.0001	250 x 7 mm 10 µm LiChrogel PS 40	☎

Hibar® RT

LiChrospher®

Best.-Nr.	Beschreibung	€
1.50316.0001	250 x 4 mm 5 µm Si100	520,00
1.50329.0001	250 x 4 mm 5 µm 100 RP-8	548,00
1.50477.0001	125 x 4 mm 5 µm 100 RP-18	493,00
1.50377.0001	250 x 4 mm 5 µm 100 RP-18	548,00
1.51483.0001	250 x 25 mm 5 µm 100 RP-18	3.070,00
1.51482.0001	250 x 25 mm 5 µm 100 RP-8	3.130,00
1.51484.0001	250 x 25 mm 5 µm 60 RP-Select B	2.900,00
1.51485.0001	250 x 25 mm 5 µm Si 60	2.717,70

LiChroCART®

LiChrosorb®

Best.-Nr.	Beschreibung	€
1.51343.0001	125 x 4 mm 5 µm Si 60	357,00
1.51351.0001	250 x 4 mm 5 µm Si 60	412,00
1.51345.0001	125 x 4 mm 5 µm RP-8	383,00
1.51353.0001	250 x 4 mm 5 µm RP-8	440,00
1.51354.0001	250 x 4 mm 10 µm RP-8	440,00
1.51349.0001	125 x 4 mm 5 µm RP-18	383,00
1.51355.0001	250 x 4 mm 5 µm RP-18	440,00
1.51356.0001	250 x 4 mm 10 µm RP-18	440,00

Hibar® RT

LiChrosorb®

Best.-Nr.	Beschreibung	€
1.50388.0001	250 x 4 mm 5 µm Si 60	545,00
1.50432.0001	125 x 4 mm 5 µm RP-8	516,00
1.50332.0001	250 x 4 mm 5 µm RP-8	574,00
1.50318.0001	250 x 4 mm 10 µm RP-8	574,00
1.50433.0001	125 x 4 mm 5 µm RP-18	516,00
1.50333.0001	250 x 4 mm 5 µm RP-18	574,00
1.50334.0001	250 x 4 mm 10 µm RP-18	574,00

LiChroCART®

LiChrospher®

Best.-Nr.	Beschreibung	€
1.50156.0001	250 x 3 mm PAH	748,00
1.50148.0001	4 x 4 mm PAH (10 Stk.)	298,00
1.50149.0001	250 x 4 mm PAH	671,00
1.50955.0001	4 x 4 mm 5 µm Si 60 Si (10 Stk.)	316,00
1.50928.0001	25 x 4 mm 5 µm Si 60 (3 Stk.)	339,00
1.50820.0001	125 x 4 mm 5 µm Si 60	391,00
1.50830.0001	250 x 4 mm 5 µm Si 60	443,00
1.50840.0001	250 x 4 mm 10 µm Si 60	443,00
1.50850.0001	250 x 10 mm 10 µm Si 60	1.219,00
1.50158.0001	125 x 3 mm 5 µm 60 RP-select B	443,00
1.50155.0001	250 x 3 mm 5 µm 60 RP-select B	529,00
1.50963.0001	4 x 4 mm 5 µm 60 RP-select B (10 Stk.)	321,00
1.50937.0001	25 x 4 mm 5 µm 60 RP-select B (3 Stk.)	404,00
1.50993.0001	75 x 4 mm 5 µm 60 RP-select B (3 Stk.)	538,00
1.50829.0001	125 x 4 mm 5 µm 60 RP-select B	443,00
1.50981.0001	125 x 4 mm 5 µm 60 RP-select B (3 Stk.)	849,00
1.50839.0001	250 x 4 mm 5 µm 60 RP-select B	529,00
1.50984.0001	250 x 4 mm 5 µm 60 RP-select B (3 Stk.)	1.042,00
1.50742.0001	250 x 4 mm 10 µm 60 RP-select B	529,00
1.50173.7082	4 x 4 mm 10 µm 60 RP-18 (10 Stk.)	☎
1.50170.7195	125 x 4 mm 5 µm WP 200 RP-4	☎
1.50140.0001	4 x 4 mm 5 µm WP 300 RP-18 (10 Stk.)	☎
1.50137.0001	250 x 4 mm 5 µm WP 300 RP-18	☎
1.50183.7114	250 x 10 mm 12 µm WP 300 RP-18*	☎

*Hibar®

LiChroCART®

LiChrospher®

Best.-Nr.	Beschreibung	€
1.50956.0001	4 x 4 mm 5 µm 100 RP-8 (10 Stk.)	326,00
1.50930.0001	25 x 4 mm 5 µm 100 RP-8 (3 Stk.)	361,00
1.50986.0001	75 x 4 mm 5 µm 100 RP-8 (3 Stk.)	478,00
1.50822.0001	125 x 4 mm 5 µm 100 RP-8	415,00
1.50942.0001	125 x 4 mm 5 µm 100 RP-8 (3 Stk.)	534,00
1.50832.0001	250 x 4 mm 5 µm 100 RP-8	470,00
1.50982.0001	250 x 4 mm 5 µm 100 RP-8 (3 Stk.)	940,00
1.50842.0001	250 x 4 mm 10 µm 100 RP-8	470,00
1.50961.0001	4 x 4 mm 5 µm 100 RP-8 endc. (10 Stk.)	307,00
1.50827.0001	125 x 4 mm 5 µm 100 RP-8 endc.	415,00
1.50837.0001	250 x 4 mm 5 µm 100 RP-8 endc.	470,00
1.50847.0001	250 x 4 mm 10 µm 100 RP-8 endc.	470,00
1.50159.0001	125 x 3 mm 5 µm 100 RP-18	415,00
1.50154.0001	250 x 3 mm 5 µm 100 RP-18	470,00
1.50957.0001	4 x 4 mm 5 µm 100 RP-18 (10 Stk.)	307,00
1.50931.0001	25 x 4 mm 5 µm 100 RP-18 (3 Stk.)	361,00
1.50987.0001	75 x 4 mm 5 µm 100 RP-18 (3 Stk.)	482,00
1.50823.0001	125 x 4 mm 5 µm 100 RP-18	400,00
1.50943.0001	125 x 4 mm 5 µm 100 RP-18 (3 Stk.)	518,00
1.50833.0001	250 x 4 mm 5 µm 100 RP-18	470,00
1.50983.0001	250 x 4 mm 5 µm 100 RP-18 (3 Stk.)	940,00
1.50170.7080	125 x 4 mm 7 µm 100 RP-18	☎
1.50174.7080	250 x 4 mm 7 µm 100 RP-18	☎
1.50170.7081	125 x 4 mm 10 µm 100 RP-18	☎
1.50843.0001	250 x 4 mm 10 µm 100 RP-18	470,00
1.50853.0001	250 x 10 mm 10 µm 100 RP-18	1.287,00
1.50962.0001	4 x 4 mm 5 µm 100 RP-18 endc. (10 Stk.)	316,00
1.50936.0001	25 x 4 mm 5 µm 100 RP-18 endc. (3 Stk.)	361,00
1.50828.0001	125 x 4 mm 5 µm 100 RP-18 endc.	415,00
1.50734.0001	125 x 4 mm 5 µm 100 RP-18 endc. (3 Stk.)	584,00
1.50838.0001	250 x 4 mm 5 µm 100 RP-18 endc.	470,00
1.50995.0001	250 x 4 mm 5 µm 100 RP-18 endc. (3 Stk.)	940,00
1.50848.0001	250 x 4 mm 10 µm 100 RP-18 endc.	470,00
1.50858.0001	250 x 10 mm 10 µm 100 RP-18 endc.	1.287,00
1.50958.0001	4 x 4 mm 5 µm 100 NH2 (10 Stk.)	316,00
1.50932.0001	25 x 4 mm 5 µm 100 NH2 (3 Stk.)	361,00
1.50824.0001	125 x 4 mm 5 µm 100 NH2	415,00
1.50834.0001	250 x 4 mm 5 µm 100 NH2	470,00
1.50844.0001	250 x 4 mm 10 µm 100 NH2	470,00
1.50175.7071	125 x 3 mm 5 µm 100 CN	☎
1.50959.0001	4 x 4 mm 5 µm 100 CN (10 Stk.)	316,00
1.50171.7071	75 x 4 mm 5 µm 100 CN	☎
1.50825.0001	125 x 4 mm 5 µm 100 CN	415,00
1.50892.0001	250 x 4 mm 5 µm 100 CN	470,00
1.51432.7071	150 x 4,6 mm 5 µm 100 CN	☎
1.51431.7071	250 x 4,6 mm 5 µm 100 CN	☎
1.50845.0001	250 x 4 mm 10 µm 100 CN	470,00
1.50960.0001	4 x 4 mm 5 µm 100 DIOL (10 Stk.)	328,00
1.50172.7075	25 x 4 mm 5 µm 100 DIOL	☎
1.50826.0001	125 x 4 mm 5 µm 100 DIOL	404,00
1.50836.0001	250 x 4 mm 5 µm 100 DIOL	470,00

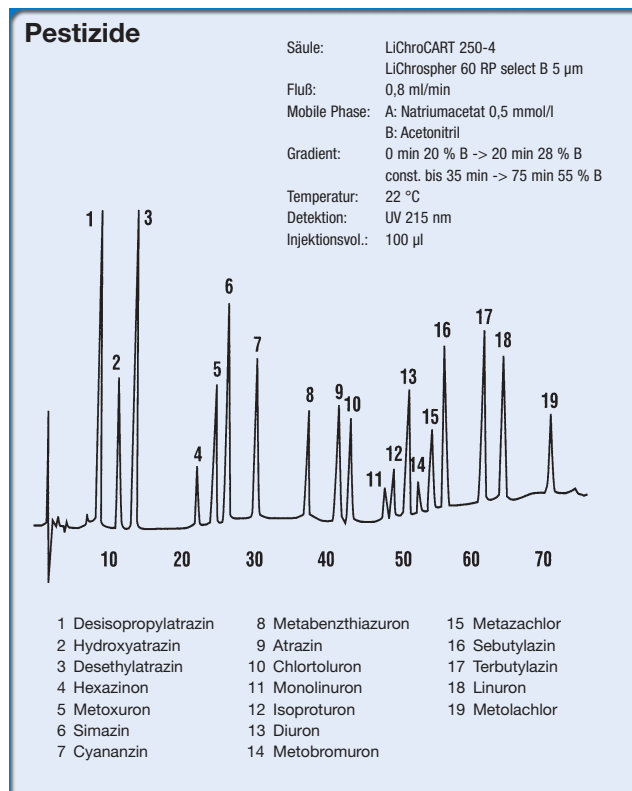

LiChroCART®

Purospher®

Best.-Nr.	Beschreibung	€
1.50237.0001	30 x 2 mm 3 µm STAR RP-18e (Satz)	291,00
1.50240.0001	55 x 2 mm 3 µm STAR RP-18e (Satz)	419,00
1.50234.7184	55 x 2 mm 3 µm STAR RP-18e	☎
1.50239.0001	30 x 4 mm 3 µm STAR RP-18e (Satz)	349,00
1.50225.0001	30 x 4 mm 3 µm STAR RP-18e (3 Stk.)	677,60
1.50242.0001	55 x 4 mm 3 µm STAR RP-18e (Satz)	419,00
1.50231.0001	55 x 4 mm 3 µm STAR RP-18e (3 Stk.)	729,00
1.51460.0001	75 x 4 mm 3 µm STAR RP-18e	372,00
1.50255.0001	125 x 2 mm 5 µm STAR RP-18e Li-CART	481,00
1.50256.0001	250 x 2 mm 5 µm STAR RP-18e Li-CART	449,00
1.50253.0001	125 x 3 mm 5 µm STAR RP-18e Li-CART	481,00
1.50254.0001	250 x 3 mm 5 µm STAR RP-18e Li-CART	539,00
1.50234.7220	55 x 2 mm 5 µm STAR RP-8e Li-CART	☎
1.50274.0001	125 x 2 mm 5 µm STAR RP-8e Li-CART	481,00
1.50275.0001	250 x 2 mm 5 µm STAR RP-8e Li-CART	449,00
1.50038.0001	125 x 3 mm 5 µm STAR RP-8e Li-CART	481,00
1.50273.0001	250 x 3 mm 5 µm STAR RP-8e Li-CART	449,00
1.50201.7127	10 x 2 mm 5 µm RP-18 Li-CART (3 Stk)	☎
1.50234.7127	55 x 2 mm 5 µm RP-18 Li-CART	☎
1.50195.7127	125 x 2 mm 5 µm RP-18 Li-CART	☎
1.50190.7127	250 x 2 mm 5 µm RP-18 Li-CART	☎
1.50236.7127	55 x 3 mm 5 µm RP-18 Li-CART	☎
1.50175.7127	125 x 3 mm 5 µm RP-18 Li-CART	☎
1.50177.7127	250 x 3 mm 5 µm RP-18 Li-CART	☎
1.50141.0001	4 x 4 mm 5 µm RP-18 (10 Stk.) Li-CART	307,00
1.50142.0001	125 x 4 mm 5 µm RP-18 Li-CART	493,00
1.50144.0001	250 x 4 mm 5 µm RP-18 Li-CART	539,00
1.51442.7127	125 x 4,6 mm 5 µm RP-18 Li-CART	☎
1.51432.7127	150 x 4,6 mm 5 µm RP-18 Li-CART	☎
1.51431.7127	250 x 4,6 mm 5 µm RP-18 Li-CART	☎
1.50178.7127	10 x 10 mm 5 µm RP-18 (2 Stk) Li-CART	☎
1.51446.7127	50 x 10 mm 5 µm RP-18 Li-CART	☎
1.51443.7127	125 x 10 mm 5 µm RP-18 Li-CART	☎
1.51444.7127	150 x 10 mm 5 µm RP-18 Li-CART	☎
1.50179.7127	250 x 10 mm 5 µm RP-18 Li-CART	☎
1.50201.7130	10 x 2 mm 5 µm RP-18e (3 Stk) Li-CART	☎
1.50234.7130	55 x 2 mm 5 µm RP-18e Li-CART	☎
1.50190.7130	250 x 2 mm 5 µm RP-18e Li-CART	☎
1.50236.7130	55 x 3 mm 5 µm RP-18e Li-CART	☎
1.50798.0001	125 x 3 mm 5 µm RP-18e Li-CART	481,00
1.51384.0001	250 x 3 mm 5 µm RP-18e Li-CART	553,00
1.50228.7130	55 x 4 mm 5 µm RP-18e Li-CART	☎
1.51442.7130	125 x 4,6 mm 5 µm RP-18e Li-CART	☎
1.51432.7130	150 x 4,6 mm 5 µm RP-18e Li-CART	☎
1.51431.7130	250 x 4,6 mm 5 µm RP-18e Li-CART	☎
1.50178.7130	10 x 10 mm 5 µm RP-18e (2 Stk) Li-CART	☎
1.51446.7130	50 x 10 mm 5 µm RP-18e Li-CART	☎
1.51443.7130	125 x 10 mm 5 µm RP-18e Li-CART	☎
1.51444.7130	150 x 10 mm 5 µm RP-18e Li-CART	☎
1.50179.7130	250 x 10 mm 5 µm RP-18e Li-CART	☎
1.50167.0001	4 x 4 mm 5 µm 120 RP-18e (10 Stk) Li-CART	307,00
1.50168.0001	125 x 4 mm 5 µm 120 RP-18e Li-CART	481,00
1.50169.0001	250 x 4 mm 5 µm 120 RP-18e Li-CART	539,00
1.50173.7131	4 x 4 mm 5 µm RP-18 HC Li-CART	☎
1.51431.7131	250 x 4,6 mm 5 µm RP-18 HC Li-CART	☎

Hibar®

Purospher®

Best.-Nr.	Beschreibung	€
1.51196.7130	30 x 4 mm 5 µm RP-18e	☎
1.50181.7130	125 x 4 mm 5 µm RP-18e	☎
1.50182.7130	250 x 4 mm 5 µm RP-18e	☎
1.50013.7130	100 x 4,6 mm 5 µm RP-18e	☎
1.50012.7130	125 x 4,6 mm 5 µm RP-18e	☎
1.50009.7130	150 x 4,6 mm 5 µm RP-18e	☎
1.00424.7130	250 x 4,6 mm 5 µm RP-18e	☎
1.50183.7130	250 x 10 mm 5 µm RP-18e	☎
1.51196.7127	30 x 4 mm 5 µm RP-18	☎
1.50181.7127	125 x 4 mm 5 µm RP-18	☎
1.50182.7127	250 x 4 mm 5 µm RP-18	☎
1.50013.7127	100 x 4,6 mm 5 µm RP-18	☎
1.50012.7127	125 x 4,6 mm 5 µm RP-18	☎
1.50009.7127	150 x 4,6 mm 5 µm RP-18	☎
1.00424.7127	250 x 4,6 mm 5 µm RP-18	☎
1.50183.7127	250 x 10 mm 5 µm RP-18	☎

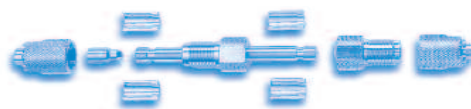

LiChroCART®

Superspher®

Best.-Nr.	Beschreibung	€
1.16054.0001	125 x 4 mm Si 60	508,00
1.16009.0001	250 x 4 mm Si 60	577,00
1.16052.0001	125 x 4 mm 60 RP-8	542,00
1.16010.0001	250 x 4 mm 60 RP-8	611,00
1.16854.0001	125 x 4 mm 60 RP-8 endcapped	542,00
1.16857.0001	250 x 4 mm 60 RP-8 endcapped	611,00
1.50205.0001	10 x 2 mm 60 RP-select B (3 Stk.)	133,00
1.50197.0001	125 x 2 mm 60 RP-select B	604,00
1.51308.0001	250 x 2 mm 60 RP-select B	680,00
1.50791.0001	125 x 3 mm 60 RP-select B	604,00
1.51288.0001	250 x 3 mm 60 RP-select B	680,00
1.50974.0001	75 x 4 mm 60 RP-select B (3 Stk.)	686,00
1.50975.0001	125 x 4 mm 60 RP-select B	604,00
1.50973.0001	250 x 4 mm 60 RP-select B	680,00
1.50204.0001	10 x 2 mm 100 RP-18 (3 Stk.)	129,00
1.16039.0001	25 x 4 mm 100 RP-18 (3 Stk.)	470,00
1.50980.0001	75 x 4 mm 100 RP-18 (3 Stk.)	616,00
1.50200.0001	125 x 2 mm 100 RP-18	542,00
1.50792.0001	125 x 3 mm 100 RP-18	542,00
1.16051.0001	125 x 4 mm 100 RP-18	542,00
1.51299.0001	250 x 3 mm 100 RP-18	611,00
1.16056.0001	250 x 4 mm 100 RP-18	611,00
1.16869.0001	25 x 4 mm 100 RP-18 endcapped (3 Stk.)	470,00
1.50198.0001	125 x 2 mm 100 RP-18 endcapped	542,00
1.50193.0001	250 x 2 mm 100 RP-18 endcapped	606,00
1.16855.0001	125 x 4 mm 100 RP-18 endcapped	542,00
1.16858.0001	250 x 4 mm 100 RP-18 endcapped	611,00

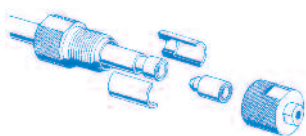

Zubehör

Hibar® RT Werkzeuge

Best.-Nr.	Beschreibung	€
1.51210.0001	Werkzeug z. Entf. von Fritten Ø 4 mm	57,80

Hibar® RT Ersatzfritten

Best.-Nr.	Beschreibung	€
1.51211.0001	Ø 4 mm 3 Stk mit PTFE-Ringdichtungen	☎
1.51220.0001	Ø 10 mm 3 Stk mit PTFE-Ringdichtungen	134,60

Hibar® & LiChroCART® Kapillarrohre

Best.-Nr.	Beschreibung	€
1.51230.0001	80 x 0,25 mm ID/AD 1/16" (10 Stk)	☎
1.51231.0001	120 x 0,25 mm ID/AD 1/16" (10 Stk)	156,30
1.15547.0001	250 x 0,2 mm ID/AD 0,5 mm (5 Stk) <i>flexible Edelstahlkapillaren</i>	☎
1.51236.0001	1.000 x 0,2 mm ID/AD 0,5 mm (3 Stk) <i>flexible Edelstahlkapillaren</i>	174,00
1.51245.0001	1.000 x 0,1 mm ID/AD 0,5 mm (1 Stk) <i>Hibar® Kapillarrohr für die Mikro-HPLC</i>	☎

LiChroCART® Montagewerkzeug

Best.-Nr.	Beschreibung	€
1.15576.0001	Hibar® LiChroCART® Montagewerkzeug 1 Zentrierhülse, 1 Stempel, 1 Werkzeug zur Entfernung von PTFE-Dichtringen aus LiChroCART-Kartuschen	35,50

LiChroCART® manu-CART®

Best.-Nr.	Beschreibung	€
1.51486.0001	manu-CART NT Kartuschenhalter f. LiChroCART® Kartuschen ID 2; 3; 4; 4,6 mm	348,00
1.51419.0001	manu-CART '10'-II Verschraubung 2 kompl. Verschraubungen f. LiChroCART® Kartuschen ID 10 mm für Kapillaran-schluß (AD 1/16" oder 0,5 mm)	425,00
1.50226.0001	Halter f. LiChroCART 55-4 Kartuschen	217,00
1.50227.0001	Halter f. LiChroCART 30-4 Kartuschen	166,00
1.50082.0001	manu-CART '4' Kopplungseinheit für LiChroCART 25-4 Kartuschen	318,00
1.50017.0001	manu-CART '4' Kartuschenhalter für LiChroCART 25-4 Kartuschen	275,00
1.50083.0001	manu-CART '4' Kopplungsteil zum Koppeln von 2 LiChroCART HPLC-Kartuschen	122,00
1.51258.0001	Druckstück f. manu-CART '4' Verschraubung	131,00
1.51257.0001	Halbschalen f. " '4' Verschraubung	92,00

Hibar® & LiChroCART® Starter Kit

Best.-Nr.	Beschreibung	€
1.13171.0001	HPLC Starter-Kit 4 Rändelschrauben für Kapillaran-schluß (AD 1/16 oder 0,5 mm) 10 PVDF- Doppelkolen für Kapillaran-schluß (AD 0,5 mm, ID 0,2 mm); 10 Filter (Edel- stahl) mit PTFE-Dichtring und 10 Keramik-Vliese für HPLC-Kartuschen LiChroCART (ID 4 mm); 3 Kopplungsteile; 6 Anpreßschrauben und 6 Klemmringe für Kapillaren (AD 1/16" oder 0,5 mm); je 1 Kapillarrohr (AD 1/16", 0,25 mm) der Länge 50, 80, 120 und 200 mm; 1 totvolumenfreies Kopplungsteil für Kapillaren (AD 1/16" oder 0,5 mm); 8 Anpreßschrauben für Kapillaran-schluß und 10 Klemmringe für Kapillaran-schluß (AD 1/16"); 3 Edelstahkapillaren (AD 0,5 mm, ID 0,2 mm), Länge 1000 mm; 2 Langhals- rändelschrauben und 6 PVDF-Doppelkolen für 6-Wege-Injektionsventile (Typ Rheodyne 7125); 10 PVDF-Doppelkolen für Kapillaran-schluß (AD 1/16")	☎
1.51193.0001	Inline Filterhalterung (Satz)	127,00
1.51192.0001	Inline Filter ADS PEEK (5 Stk)	169,00
1.51194.0001	Filtereinsatz Inline 2 µm (10 Stk)	94,50

LiChroCART® Verschußelemente

Best.-Nr.	Beschreibung	€
1.51195.0001	Verschußelement PVDF 10 Stk.	☎

LiChroCART® manu-fix®

Best.-Nr.	Beschreibung	€
1.16333.0001	manu-fix Halter f. LiChroCART® 4-4 Vorsäulen 1 Halterung, zweiteilig, Edelstahl	☎

Hibar® & LiChroCART® Zubehör

Best.-Nr.	Beschreibung	€
1.51214.0001	Montageset für Kapillaran-schluß 1/16" je 1 Kapillarrohr (AD 1/16"). ID 0,25 mm) der Längen 50, 80 120 & 200 mm 1 totvolumenfreies Kopplungsteil für Kapillaren (AD 1/16") oder 0,5 mm 8 Anpreßschrauben für Kapillaran-schluß (AD 1/16") 10 Klemmringe für Kapillaran-schluß (AD 1/16")	☎
1.51213.0001	Kopplungsset (totvolumenfrei) für Kapillaren 1/16" oder 0,5 mm AD 3 Kopplungsteile, 6 Anpreßschrauben, 6 Klemmringe	☎
1.51252.0001	Kopplungsteil (totvolumenfrei) für Kapillaren 1/16" oder 0,5 mm AD (3 Stk)	308,00
1.51216.0001	Anpreßschrauben f. Kapillaran-schluß 1/16" (10 Stk)	158,00
1.15545.0001	Hibar-Rändelschrauben f. Kapillarverbindungen 0,2 mm ID/AD 0,5 mm mit PVDF-Doppelkolen (4 Stk)	166,00
1.51237.0001	Hibar-Rändelschrauben m. langem Hals und PVDF-Kolen f. 6-Wege-Ventile (Rheodyne) 2 Rändelschrauben (Edelstahl), 6 PVDF-Doppelkolen	213,00
1.51217.0001	Schneidringe für Kapillaran-schluß 1/16" 20 Klemmringe (Kegelwinkel 18°, Edelstahl)	137,00
1.51238.0001	Hibar-PVDF-Doppelkolen für Kapillaran-schluß 1/16" mit Rändelschraube (10 Stk)	186,00
1.15546.0001	Hibar-PVDF-Doppelkolen (10 Stk)	174,00
1.51218.0001	Verschußschrauben PVDF (20 Stk)	☎
1.16217.0001	Vorsäulenhalterung für PVDF-Kartuschen 4-4	178,00