

# A N A L Y S E N T E C H N I K



# 2011

HPLC-Säulen & Materialien

Entwicklung • Herstellung  
Vertrieb • Beratung

### HPLC-Säulen

- Neu + Refill
- umfangreiche Auswahl an Packungsmaterialien
- micro • analytisch • präparativ

### Vertriebspartner für:

- GRACEVYDAC
- GL-SCIENCES
- THERMO SCIENTIFIC
- Eka-Nobel/KROMASIL
- CHROMTECH
- DAICEL
- MERCK
- ES-INDUSTRIES
- AMT/HALO

### MZ-PAH

- Trennung von PAK's

### MZ-PBM

- Trennung von Pestiziden

### MZ-Gel SD<sup>plus</sup>

- GPC-Säulen Organisch Styrol-Divinylbenzol

### HEMA/HEMA-Bio

- GPC-Säulen wässrig

### Zubehör

- RHEODYNE-Ventile
- EXMIRE-Spritzen
- Vorsäulensysteme
- Kapillaren
- Verschraubungen uvm.

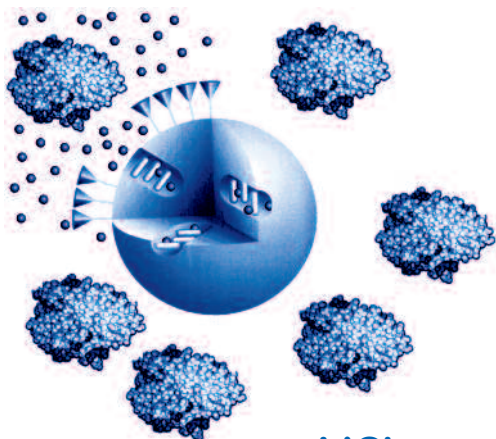

ChiraSep®

Chiraspher®

ChiraDex®

Purospher®

Superspher®

LiChrospher® ADS

LiChrosil®

Aluspher®

LiChrogel® PS

LiChrospher®

Purospher® STAR

LiChrosorb®

HitHunter®

Chromolith®

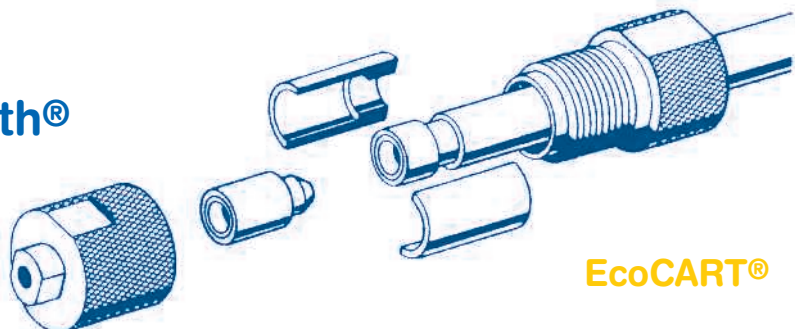

EcoCART®

Hibar®

MicroCART®

ManuCART®

LiChroCART®

Hibar® RT

**Aktuelle Infos im Internet:**  
<http://www.mz-at.de>  
e-mail: [info@mz-at.de](mailto:info@mz-at.de)



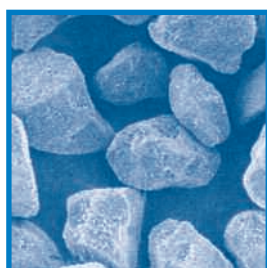

## Lichrosorb®

- seit vielen Jahren bewährt
- total porös
- gebrochene Teilchen
- fein klassiert
- viele Modifizierungen erhältlich
- kontrollierte Belegung

### Bulkmaterialien

### Lichrosorb®

Best.-Nr.	Beschreibung	Menge	€
1.09309.0010	10 µm Si 100	10 g	66,80
1.09318.0010	10 µm RP-8	10 g	303,00
1.09318.0100	10 µm RP-8	100 g	2.530,00
1.09333.0010	5 µm RP-18	10 g	333,00
1.09334.0010	10 µm RP-18	10 g	303,00

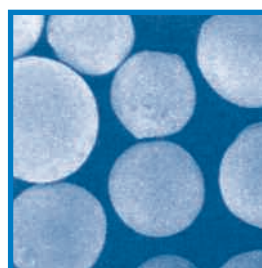

## Lichrospher®

- total porös
- Teilchengröße: 5 & 10 µm
- Porenweiten: 6, 10 & 30 nm
- feinklassiert
- viele Modifizierungen erhältlich
- kontrollierte Belegung

### Bulkmaterialien

### Lichrospher®

Best.-Nr.	Beschreibung	Menge	€
1.19640.0010	5 µm Si 60	10 g	202,00
1.19640.0100	5 µm Si 60	100 g	1.650,00
1.19629.0010	10 µm Si 60	10 g	202,00
1.19641.0010	5 µm 60 RP-select B	10 g	684,00
1.19642.0010	10 µm 60 RP-select B	10 g	609,00
1.16129.0010	5 µm 100 RP-8	10 g	535,00
1.16139.0010	10 µm 100 RP-8	10 g	535,00
1.19636.0010	5 µm 100 RP-8 endcapped	10 g	535,00
1.19632.0010	10 µm 100 RP-8 endcapped	10 g	535,00
1.16177.0010	5 µm 100 RP-18	10 g	535,00
1.16177.0100	5 µm 100 RP-18	100 g	4.290,00
1.16105.0010	10 µm 100 RP-18	10 g	535,00
1.19637.0010	5 µm 100 RP-18 endcapped	10 g	535,00
1.19637.0100	5 µm 100 RP-18 endcapped	100 g	4.200,00
1.19633.0010	10 µm 100 RP-18 endcapped	10 g	535,00
1.16178.0010	5 µm 100 NH <sub>2</sub>	10 g	535,00
1.19638.0010	5 µm 100 CN	10 g	535,00
1.19631.0010	10 µm 100 CN	10 g	486,00
1.16152.0010	5 µm 100 DIOL	10 g	535,00

### Bulkmaterialien

### Superspher®

Best.-Nr.	Beschreibung	Menge	€
1.19609.0010	4 µm Si 60 für die HPLC	10 g	333,00
1.19612.0010	4 µm 60 RP-8	10 g	626,00
1.19617.0010	4 µm 60 RP-8 endcapped	10 g	626,00
1.19617.0100	4 µm 60 RP-8 endcapped	100 g	4.250,00
1.19613.0010	4 µm 100 RP-18	10 g	626,00
1.19618.0010	4 µm 100 RP-18 endcapped	10 g	626,00
1.19643.0010	4 µm 60 RP-select B	10 g	795,00

## Erkältungsmittel

Säule: LiChroCART 125-4  
Purospher RP-18 5 µm  
Fluß: 1,0 ml/min  
Mobile Phase: 50 mM Phosphatpuffer  
pH 3,0 / Acetonitril (85:15)  
Temperatur: Raumtemperatur  
Detektion: UV 220 nm  
Injektionsvol.: 10 µl

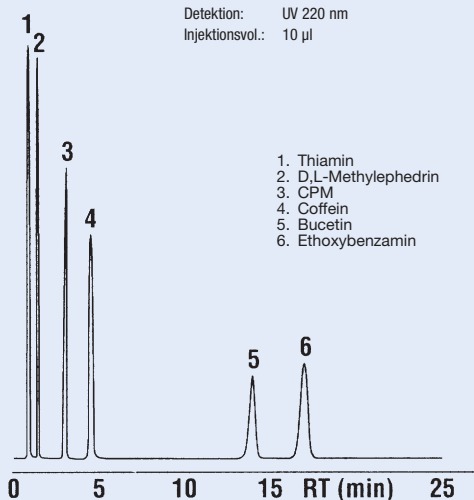

1. Thiamin
2. D,L-Methylephedrin
3. CPM
4. Coffein
5. Bucetin
6. Ethoxybenzamin

## LiChrospher ADS®

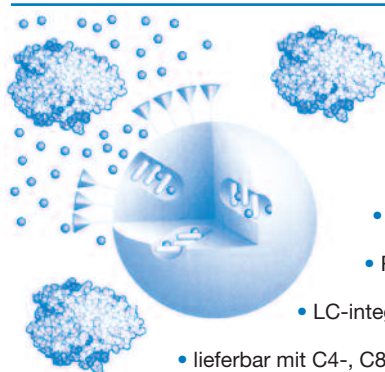

- hoher Probendurchsatz
- hohe Reproduzierbarkeit
- niedrige Kosten pro Probe
- Restricted Access-Material
- LC-integrierte Probenaufbereitung
- lieferbar mit C4-, C8- sowie C18-Modifizierung
- direkte Injektion unbehandelter biologischer Flüssigkeiten

### Bulkmaterialien

### LiChrospher ADS

Best.-Nr.	Beschreibung	Menge	€
1.50347.0010	RP18 ADS 25 µm für die integrierte Probenaufbereitung	10 g	1.850,00

**LiChroCART®**

**ChiraDex®**

Best.-Nr.	Beschreibung	€
1.50201.7004	10 x 2 mm 5 µm 100 LiChroCART 3 Stk.	☎
1.50229.7004	30 x 2 mm 5 µm 100 LiChroCART	☎
1.50234.7004	55 x 2 mm 5 µm 100 LiChroCART	☎
1.50195.7004	125 x 2 mm 5 µm 100 LiChroCART	☎
1.50190.7004	250 x 2 mm 5 µm 100 LiChroCART	☎
1.50233.7004	30 x 3 mm 5 µm 100 LiChroCART	☎
1.50236.7004	55 x 3 mm 5 µm 100 LiChroCART	☎
1.50175.7004	125 x 3 mm 5 µm 100 LiChroCART	☎
1.50177.7004	250 x 3 mm 5 µm 100 LiChroCART	☎
1.50117.0001	4 x 4 mm 5 µm 100 Vorsäule 10 Stk.	263,00
1.50302.7004	30 x 4 mm 5 µm 100 LiChroCART	☎
1.50228.7004	55 x 4 mm 5 µm 100 LiChroCART	☎
1.50171.7004	75 x 4 mm 5 µm 100 LiChroCART	☎
1.50170.7004	125 x 4 mm 5 µm 100 LiChroCART	☎
1.51333.0001	250 x 4 mm 5 µm 100 Kartusche	837,00
1.51448.7004	100 x 4,6 mm 5 µm 100 LiChroCART	☎
1.51442.7004	125 x 4,6 mm 5 µm 100 LiChroCART	☎
1.51432.7004	150 x 4,6 mm 5 µm 100 LiChroCART	☎
1.51431.7004	250 x 4,6 mm 5 µm 100 LiChroCART	☎

**Hibar®**

**ChiraDex®**

Best.-Nr.	Beschreibung	€
1.00423.7004	250 x 3 mm 5 µm 100 Hibar	☎
1.51196.7004	30 x 4 mm 5 µm 100 Hibar	☎
1.50181.7004	125 x 4 mm 5 µm 100 Hibar	☎
1.50182.7004	250 x 4 mm 5 µm 100 Hibar	☎
1.50013.7004	100 x 4,6 mm 5 µm 100 Hibar	☎
1.50012.7004	125 x 4,6 mm 5 µm 100 Hibar	☎
1.50009.7004	150 x 4,6 mm 5 µm 100 Hibar	☎
1.00424.7004	250 x 4,6 mm 5 µm 100 Hibar	☎

**Methadon**

Säule: LiChroCART 250-4  
 ChiraDex  
 Fluß: 0,8 ml/min  
 Mobile Phase: Triethylammoniumacetat-Lösung  
 (1 % pH 4,1/Acetonitril 98/2 (v/v))  
 Detektion: UV 254 nm

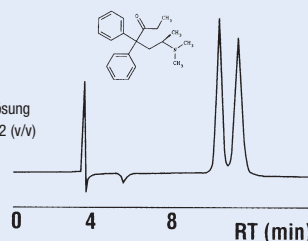

**Hibar/LiChroCART**

**Chiraspher 100 NT**

Best.-Nr.	Beschreibung	€
1.00423.7006	250 x 3 mm 5 µm Hibar	☎
1.51196.7006	30 x 4 mm 5 µm Hibar	☎
1.50182.7006	250 x 4 mm 5 µm Hibar	☎
1.50181.7006	125 x 4 mm 5 µm Hibar	☎
1.50013.7006	100 x 4,6 mm 5 µm Hibar	☎
1.50012.7006	125 x 4,6 mm 5 µm Hibar	☎
1.50009.7006	150 x 4,6 mm 5 µm Hibar	☎
1.00424.7006	250 x 4,6 mm 5 µm Hibar	☎
1.50183.7006	250 x 10 mm 5 µm Hibar	☎
1.50201.7006	10 x 2 mm 5 µm LiChroCART 3 Stk.	☎
1.50229.7006	30 x 2 mm 5 µm LiChroCART	☎
1.50234.7006	55 x 2 mm 5 µm LiChroCART	☎
1.50195.7006	125 x 2 mm 5 µm LiChroCART	☎
1.50190.7006	250 x 2 mm 5 µm LiChroCART	☎
1.50233.7006	30 x 3 mm 5 µm LiChroCART	☎
1.50236.7006	55 x 3 mm 5 µm LiChroCART	☎
1.50175.7006	125 x 3 mm 5 µm LiChroCART	☎
1.50177.7006	250 x 3 mm 5 µm LiChroCART	☎
1.50173.7006	4 x 4 mm 5 µm LiChroCART 10 Stk.	☎
1.50302.7006	30 x 4 mm 5 µm LiChroCART	☎
1.50228.7006	55 x 4 mm 5 µm LiChroCART	☎
1.50171.7006	75 x 4 mm 5 µm LiChroCART	☎
1.50170.7006	125 x 4 mm 5 µm LiChroCART	☎
1.51448.7006	100 x 4,6 mm 5 µm LiChroCART	☎
1.51442.7006	125 x 4,6 mm 5 µm LiChroCART	☎
1.51432.7006	150 x 4,6 mm 5 µm LiChroCART	☎
1.51431.7006	250 x 4,6 mm 5 µm LiChroCART	☎
1.50178.7006	10 x 10 mm 5 µm LiChroCART	☎
1.51446.7006	50 x 10 mm 5 µm LiChroCART	☎
1.51449.7006	75 x 10 mm 5 µm LiChroCART	☎
1.51445.7006	100 x 10 mm 5 µm LiChroCART	☎
1.51443.7006	125 x 10 mm 5 µm LiChroCART	☎
1.51444.7006	150 x 10 mm 5 µm LiChroCART	☎
1.50179.7006	250 x 10 mm 5 µm LiChroCART	☎

**Hibar/LiChroCART**

**Chirasep 100 DNBPG**

Best.-Nr.	Beschreibung	€
1.00423.7005	250 x 3 mm 5 µm Hibar	☎
1.51196.7005	30 x 4 mm 5 µm Hibar	☎
1.50181.7005	125 x 4 mm 5 µm Hibar	☎
1.50182.7005	250 x 4 mm 5 µm Hibar	☎
1.50013.7005	100 x 4,6 mm 5 µm Hibar	☎
1.50012.7005	125 x 4,6 mm 5 µm Hibar	☎
1.50009.7005	150 x 4,6 mm 5 µm Hibar	☎
1.00424.7005	250 x 4,6 mm 5 µm Hibar	☎
1.50183.7005	250 x 10 mm 5 µm Hibar	☎
1.50201.7005	10 x 2 mm 5 µm LiChroCART 3 Stk.	☎
1.50229.7005	30 x 2 mm 5 µm LiChroCART	☎
1.50234.7005	55 x 2 mm 5 µm LiChroCART	☎
1.50195.7005	125 x 2 mm 5 µm LiChroCART	☎
1.50190.7005	250 x 2 mm 5 µm LiChroCART	☎
1.50236.7005	55 x 3 mm 5 µm LiChroCART	☎
1.50233.7005	30 x 3 mm 5 µm LiChroCART	☎
1.50175.7005	125 x 3 mm 5 µm LiChroCART	☎
1.50177.7005	250 x 3 mm 5 µm LiChroCART	☎
1.50302.7005	30 x 4 mm 5 µm LiChroCART	☎
1.50228.7005	55 x 4 mm 5 µm LiChroCART	☎
1.50171.7005	75 x 4 mm 5 µm LiChroCART	☎
1.50170.7005	125 x 4 mm 5 µm LiChroCART	☎
1.50174.7005	250 x 4 mm 5 µm LiChroCART	☎
1.51448.7005	100 x 4,6 mm 5 µm LiChroCART	☎
1.51442.7005	125 x 4,6 mm 5 µm LiChroCART	☎
1.51432.7005	150 x 4,6 mm 5 µm LiChroCART	☎
1.51431.7005	250 x 4,6 mm 5 µm LiChroCART	☎
1.50178.7005	10 x 10 mm 5 µm LiChroCART 2 Stk.	☎
1.51446.7005	50 x 10 mm 5 µm LiChroCART	☎
1.51449.7005	75 x 10 mm 5 µm LiChroCART	☎
1.51445.7005	100 x 10 mm 5 µm LiChroCART	☎
1.51443.7005	125 x 10 mm 5 µm LiChroCART	☎
1.51444.7005	150 x 10 mm 5 µm LiChroCART	☎
1.50179.7005	250 x 10 mm 5 µm LiChroCART	☎

## LiChrospher ADS®

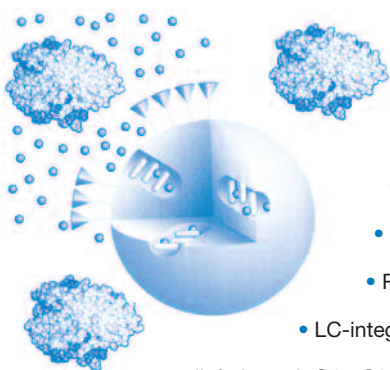

- hoher Probendurchsatz
- hohe Reproduzierbarkeit
- niedrige Kosten pro Probe
- Restricted Access-Material
- LC-integrierte Probenaufbereitung
- lieferbar mit C4-, C8- sowie C18-Modifizierung
- direkte Injektion unbehandelter biologischer Flüssigkeiten

### LiChroCART®

### LiChrospher® ADS

Best.-Nr.	Beschreibung	€
1.50210.0001	25 x 4 mm HPLC Selektivitätskit <i>enthält: je 1 LiChroCART 25-4 RP-4 ADS / RP-8 ADS / RP-18 ADS + 1 manu-CART</i>	1.600,00
1.50380.0001	25 x 2 mm RP-4 ADS	382,00
1.50381.0001	25 x 2 mm RP-4 ADS (3 Stk.)	1.020,00
1.50206.0001	25 x 4 mm RP-4 ADS (Satz) <i>enthält: 1 LiChroCART 25-4 RP-4 ADS 1 manu-CART</i>	636,00
1.50208.0001	25 x 4 mm RP-4 ADS (3 Stk.)	1.400,00
1.50382.0001	25 x 2 mm RP-8 ADS	382,00
1.50383.0001	25 x 2 mm RP-8 ADS (3 Stk.)	987,00
1.50207.0001	25 x 4 mm RP-8 ADS (Satz) <i>enthält: 1 LiChroCART 25-4 RP-8 ADS 1 manu-CART</i>	677,00
1.50209.0001	25 x 4 mm RP-8 ADS (3 Stk.)	1.470,00
1.50386.0001	25 x 2 mm RP-18 ADS (3 Stk.)	1.050,00
1.50385.0001	25 x 2 mm RP-18 ADS	382,00
1.50187.0001	25 x 4 mm RP-18 ADS (Satz) <i>enthält: 1 LiChroCART 25-4 RP-18 ADS 1 manu-CART</i>	628,00
1.50947.0001	25 x 4 mm RP-18 ADS (3 Stk.)	1.470,00

## Edelstahl-Säulen HitHunter®

### HitHunter®

### Purospher®

Best.-Nr.	Beschreibung	€
1.50278.0001	30 x 10 mm 5 µm STAR RP-8 endc.	☎
1.50283.0001	50 x 10 mm 5 µm STAR RP-18 endc.	☎
1.50282.0001	50 x 10 mm 5 µm STAR RP-8 endc.	☎
1.50287.0001	100 x 10 mm 5 µm STAR RP-18 endc.	☎
1.50286.0001	100 x 10 mm 5 µm STAR RP-8 endc.	☎
1.50292.0001	30 x 21,2 mm 5 µm STAR RP-18 endc.	☎
1.50296.0001	50 x 21,2 mm 5 µm STAR RP-18 endc.	☎
1.50295.0001	50 x 21,2 mm 5 µm STAR RP-8 endc.	☎
1.50299.0001	100 x 21,2 mm 5 µm STAR RP-8 endc.	☎
1.50322.0001	30 x 25 mm 5 µm STAR RP-18 endc.	☎
1.50319.0001	30 x 25 mm 5 µm STAR RP-8 endc.	☎
1.50326.0001	50 x 25 mm 5 µm STAR RP-18 endc.	☎
1.50325.0001	50 x 25 mm 5 µm STAR RP-8 endc.	☎

HitHunter® Säulen sind optimiert f. d. kombinatorische Chemie

## HPLC-Säulen

## Polyspher®

Best.-Nr.	Beschreibung	€
1.51184.0001	10 x 3 mm IC AN-S 3 Stk Vorsäulen	☎
1.19673.0001	250 x 4 mm IC Scout column	660,00

## LiChroCART®

## Nucleosil®

Best.-Nr.	Beschreibung	€
1.51402.0003	125 x 4 mm 5 µm C8	317,00
1.51387.0003	250 x 4 mm 5 µm C8	381,00
1.51377.0003	250 x 4 mm 10 µm C8	☎
1.51324.0003	4 x 4 mm 5 µm C18 (10 Stk)	274,00
1.51329.0003	125 x 4 mm 5 µm C18	338,00
1.51388.0003	250 x 4 mm 5 µm C18	401,00
1.51378.0003	250 x 4 mm 10 µm C18	380,00

## HPLC-Fertigsäule RT

## LiChrosil® CA

Best.-Nr.	Beschreibung	€
1.50160.0001	10 x 4,6 mm LiChrosil IC CA	☎

## LiChroCART®

## Aluspher®

Best.-Nr.	Beschreibung	€
1.51310.0001	4 x 4 mm 5 µm Al 100 (10 Stk.)	259,00
1.51311.0001	4 x 4 mm 5 µm 100 RP-select B (10 Stk.)	259,00
1.51315.0001	125 x 4 mm 5 µm 100 RP-select B	573,00
1.51318.0001	250 x 4 mm 5 µm 100 RP-select B	677,00

## Glaskartuschen EcoCART®



### EcoCART®

### 125 x 3 mm

Best.-Nr.	Beschreibung	€
1.51233.0001	5 µm LiChrospher 60 RP-select B (3 Stk)	781,00
1.51232.0001	5 µm LiChrospher 100 RP-18 (3 Stk)	718,00
1.51427.0001	5 µm LiChrospher 100 RP-18 endc. (3 Stk)	718,00
1.51425.0001	5 µm Superspher 60 RP-select B	321,00
1.51423.0001	5 µm Superspher 100 RP-18 endc.	321,00
1.50180.7130	5 µm Purospher RP-18e	☎
1.50180.7127	5 µm Purospher RP-18	☎
1.50180.7005	5 µm Chirasep 100 DNBPG	☎
1.50180.7004	5 µm ChiraDex 100	☎
1.50180.7006	5 µm Chiraspher 100	☎

### EcoCART®

### Zubehör

Best.-Nr.	Beschreibung	€
1.51207.0001	Halterung f. EcoCART 125-3 <i>1 Einspannrohr, 2 manu-CART '4' Überwurfmuttern, 1 Vorsäulenhalter</i>	341,00
1.51420.0001	manu-CART '4' Zusatzkit f. EcoCART 125-3 <i>1 Einspannrohr, 1 Vorsäulenhalter</i>	115,00

## Chromolith®

### Chromolith® - monolithische HPLC-Fertigsäulen

Best.-Nr.	Beschreibung	€
1.50403.0001	150 x 0,05 mm CapRod RP18e	1.190,00
1.50426.0001	50 x 0,1 mm CapRod RP18e Trap	213,00
1.50402.0001	150 x 0,1 mm CapRod RP18e	1.110,00
1.50404.0001	150 x 0,1 mm CapRod RP18e HR	1.200,00
1.50400.0001	150 x 0,1 mm CapRod RP8e	1.110,00
1.50409.0001	50 x 0,2 mm CapRod RP18e TRAP	343,00
1.50405.0001	150 x 0,2 mm CapRod RP18e	1.020,00
1.50407.0001	150 x 0,2 mm CapRod RP18e HR	1.210,00
1.52008.0001	5 x 2,1 mm RP-18e Vorsäulenkit	276,00
1.52009.0001	5 x 2,1 mm RP-18e Vorsäule 3 Stück	155,00
1.52014.0001	25 x 2,1 mm RP-18e Flash	457,00
1.52007.0001	50 x 2,1 mm RP-18e Fastgradient	596,00
1.52006.0001	100 x 2,1 mm RP-18e	708,00
1.52004.0001	5 x 3,0 mm RP-18e Vorsäulenkit	224,00
1.52005.0001	5 x 3,0 mm RP-18e Vorsäule 3 Stück	148,00
1.52003.0001	25 x 3,0 mm RP-18e Flash	356,00
1.52002.0001	50 x 3,0 mm SpeedROD RP-18e	562,00
1.52001.0001	100 x 3,0 mm RP-18e	864,00
1.51470.0001	5 x 4,6 mm RP-18e Vorsäulenkit	285,00
1.51451.0001	5 x 4,6 mm RP-18e Vorsäule 3 Stück	210,00
1.51471.0001	10 x 4,6 mm RP-18e Vorsäulenkit	317,00
1.51452.0001	10 x 4,6 mm RP-18e Vorsäule 3 Stück	252,00
1.51463.0001	25 x 4,6 mm Flash RP-18e	361,00
1.51450.0001	50 x 4,6 mm SpeedROD RP-18e	540,00
1.02129.0001	100 x 4,6 mm Performance RP-18e	716,00
1.51466.0001	100 x 4,6 mm Validierungskit 3 Stk. RP-18e	2.120,00
1.51465.0001	100 x 4,6 mm Performance Si	745,00
1.51468.0001	100 x 4,6 mm Performance RP-8e	745,00
1.52016.0001	100 x 10 mm Chromolith Semiprep RP-18e	1.640,00
1.25251.0001	100 x 25 mm Chromolith Prep Si	6.030,00
1.25252.0001	100 x 25 mm Chromolith Prep RP-18e	6.280,00

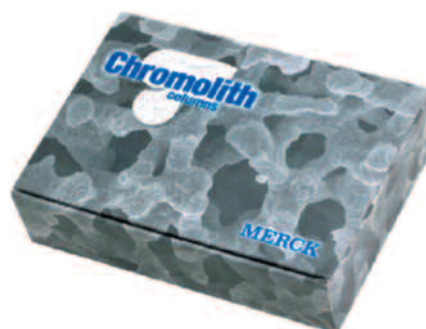

### Chromolith® - Zubehör

Best.-Nr.	Beschreibung	€
1.25254.0001	Dichtungset für Chromolith prep	291,00
1.25256.0001	Satz Endverschraubungen Chromolith prep	561,00
1.25257.0001	Frittenset für Chromolith prep	201,00
1.25255.0001	Werkzeugset für Chromolith prep	277,00
1.51467.0001	Kopplungsstück, totvolumenfrei	46,40
1.25259.0001	Chromolith prep Kopplungsteil	815,00

### Hibar® RT

### LiChroGel® PS

Best.-Nr.	Beschreibung	€
1.50056.0001	250 x 7 mm 10 µm LiChroGel PS 40	☎

### Hibar® RT

### LiChrospher®

Best.-Nr.	Beschreibung	€
1.50316.0001	250 x 4 mm 5 µm Si100	496,00
1.50329.0001	250 x 4 mm 5 µm 100 RP-8	527,00
1.50477.0001	125 x 4 mm 5 µm 100 RP-18	466,00
1.50377.0001	250 x 4 mm 5 µm 100 RP-18	527,00
1.51483.0001	250 x 25 mm 5 µm 100 RP-18	2.490,00
1.51482.0001	250 x 25 mm 5 µm 100 RP-8	2.540,00
1.51484.0001	250 x 25 mm 5 µm 60 RP-Select B	2.360,00
1.51485.0001	250 x 25 mm 5 µm Si 60	2.250,00

### LiChroCART®

### LiChrosorb®

Best.-Nr.	Beschreibung	€
1.51343.0001	125 x 4 mm 5 µm Si 60	299,00
1.51351.0001	250 x 4 mm 5 µm Si 60	333,00
1.51345.0001	125 x 4 mm 5 µm RP-8	315,00
1.51353.0001	250 x 4 mm 5 µm RP-8	352,00
1.51354.0001	250 x 4 mm 10 µm RP-8	352,00
1.51349.0001	125 x 4 mm 5 µm RP-18	315,00
1.51355.0001	250 x 4 mm 5 µm RP-18	352,00
1.51356.0001	250 x 4 mm 10 µm RP-18	352,00

### Hibar® RT

### LiChrosorb®

Best.-Nr.	Beschreibung	€
1.50388.0001	250 x 4 mm 5 µm Si 60	476,00
1.50432.0001	125 x 4 mm 5 µm RP-8	456,00
1.50332.0001	250 x 4 mm 5 µm RP-8	498,00
1.50318.0001	250 x 4 mm 10 µm RP-8	498,00
1.50433.0001	125 x 4 mm 5 µm RP-18	456,00
1.50333.0001	250 x 4 mm 5 µm RP-18	498,00
1.50334.0001	250 x 4 mm 10 µm RP-18	498,00

**LiChroCART®**

**LiChrospher®**

Best.-Nr.	Beschreibung	€
1.50156.0001	250 x 3 mm PAH	641,00
1.50148.0001	4 x 4 mm PAH (10 Stk.)	258,00
1.50149.0001	250 x 4 mm PAH	581,00
1.50955.0001	4 x 4 mm 5 µm Si 60 Si (10 Stk.)	258,00
1.50928.0001	25 x 4 mm 5 µm Si 60 (3 Stk.)	285,00
1.50820.0001	125 x 4 mm 5 µm Si 60	307,00
1.50830.0001	250 x 4 mm 5 µm Si 60	358,00
1.50840.0001	250 x 4 mm 10 µm Si 60	358,00
1.50850.0001	250 x 10 mm 10 µm Si 60	973,00
1.50158.0001	125 x 3 mm 5 µm 60 RP-select B	343,00
1.50155.0001	250 x 3 mm 5 µm 60 RP-select B	419,00
1.50963.0001	4 x 4 mm 5 µm 60 RP-select B (10 Stk.)	258,00
1.50937.0001	25 x 4 mm 5 µm 60 RP-select B (3 Stk.)	341,00
1.50993.0001	75 x 4 mm 5 µm 60 RP-select B (3 Stk.)	419,00
1.50829.0001	125 x 4 mm 5 µm 60 RP-select B	352,00
1.50981.0001	125 x 4 mm 5 µm 60 RP-select B (3 Stk.)	713,00
1.50839.0001	250 x 4 mm 5 µm 60 RP-select B	429,00
1.50984.0001	250 x 4 mm 5 µm 60 RP-select B (3 Stk.)	933,00
1.50742.0001	250 x 4 mm 10 µm 60 RP-select B	429,00
1.50173.7082	4 x 4 mm 10 µm 60 RP-18 (10 Stk.)	☎
1.50170.7195	125 x 4 mm 5 µm WP 200 RP-4	☎
1.50140.0001	4 x 4 mm 5 µm WP 300 RP-18 (10 Stk.)	259,00
1.50137.0001	250 x 4 mm 5 µm WP 300 RP-18	485,00
1.50183.7114	250 x 10 mm 12 µm WP 300 RP-18*	☎

\*Hibar®

**LiChroCART®**

**LiChrospher®**

Best.-Nr.	Beschreibung	€
1.50956.0001	4 x 4 mm 5 µm 100 RP-8 (10 Stk.)	258,00
1.50930.0001	25 x 4 mm 5 µm 100 RP-8 (3 Stk.)	301,00
1.50986.0001	75 x 4 mm 5 µm 100 RP-8 (3 Stk.)	374,00
1.50822.0001	125 x 4 mm 5 µm 100 RP-8	326,00
1.50942.0001	125 x 4 mm 5 µm 100 RP-8 (3 Stk.)	417,00
1.50832.0001	250 x 4 mm 5 µm 100 RP-8	392,00
1.50982.0001	250 x 4 mm 5 µm 100 RP-8 (3 Stk.)	776,00
1.50842.0001	250 x 4 mm 10 µm 100 RP-8	392,00
1.50945.0001	10 x 10 mm 10 µm 100 RP-8 (2 Stk.)	242,00
1.50961.0001	4 x 4 mm 5 µm 100 RP-8 endc. (10 Stk.)	258,00
1.50827.0001	125 x 4 mm 5 µm 100 RP-8 endc.	326,00
1.50837.0001	250 x 4 mm 5 µm 100 RP-8 endc.	392,00
1.50847.0001	250 x 4 mm 10 µm 100 RP-8 endc.	392,00
1.50159.0001	125 x 3 mm 5 µm 100 RP-18	352,00
1.50154.0001	250 x 3 mm 5 µm 100 RP-18	429,00
1.50957.0001	4 x 4 mm 5 µm 100 RP-18 (10 Stk.)	258,00
1.50931.0001	25 x 4 mm 5 µm 100 RP-18 (3 Stk.)	301,00
1.50987.0001	75 x 4 mm 5 µm 100 RP-18 (3 Stk.)	374,00
1.50823.0001	125 x 4 mm 5 µm 100 RP-18	326,00
1.50943.0001	125 x 4 mm 5 µm 100 RP-18 (3 Stk.)	417,00
1.50833.0001	250 x 4 mm 5 µm 100 RP-18	392,00
1.50983.0001	250 x 4 mm 5 µm 100 RP-18 (3 Stk.)	776,00
1.50170.7080	125 x 4 mm 7 µm 100 RP-18	☎
1.50174.7080	250 x 4 mm 7 µm 100 RP-18	☎
1.50170.7081	125 x 4 mm 10 µm 100 RP-18	☎
1.50843.0001	250 x 4 mm 10 µm 100 RP-18	392,00
1.50853.0001	250 x 10 mm 10 µm 100 RP-18	1.130,00
1.50962.0001	4 x 4 mm 5 µm 100 RP-18 endc. (10 Stk.)	258,00
1.50936.0001	25 x 4 mm 5 µm 100 RP-18 endc. (3 Stk.)	301,00
1.50828.0001	125 x 4 mm 5 µm 100 RP-18 endc.	326,00
1.50734.0001	125 x 4 mm 5 µm 100 RP-18 endc. (3 Stk.)	498,00
1.50838.0001	250 x 4 mm 5 µm 100 RP-18 endc.	392,00
1.50995.0001	250 x 4 mm 5 µm 100 RP-18 endc. (3 Stk.)	776,00
1.50848.0001	250 x 4 mm 10 µm 100 RP-18 endc.	392,00
1.50858.0001	250 x 10 mm 10 µm 100 RP-18 endc.	1.130,00
1.50958.0001	4 x 4 mm 5 µm 100 NH2 (10 Stk.)	258,00
1.50932.0001	25 x 4 mm 5 µm 100 NH2 (3 Stk.)	301,00
1.50824.0001	125 x 4 mm 5 µm 100 NH2	326,00
1.50834.0001	250 x 4 mm 5 µm 100 NH2	392,00
1.50844.0001	250 x 4 mm 10 µm 100 NH2	392,00
1.50959.0001	125 x 2 mm 5 µm 100 CN	258,00
1.50175.7071	125 x 3 mm 5 µm 100 CN	☎
1.50959.0001	4 x 4 mm 5 µm 100 CN (10 Stk.)	258,00
1.50171.7071	75 x 4 mm 5 µm 100 CN	☎
1.50825.0001	125 x 4 mm 5 µm 100 CN	326,00
1.50892.0001	250 x 4 mm 5 µm 100 CN	392,00
1.51432.7071	150 x 4,6 mm 5 µm 100 CN	☎
1.51431.7071	250 x 4,6 mm 5 µm 100 CN	☎
1.50845.0001	250 x 4 mm 10 µm 100 CN	392,00
1.50960.0001	4 x 4 mm 5 µm 100 DIOL (10 Stk.)	258,00
1.50172.7075	25 x 4 mm 5 µm 100 DIOL	☎
1.50826.0001	125 x 4 mm 5 µm 100 DIOL	326,00
1.50836.0001	250 x 4 mm 5 µm 100 DIOL	392,00

**Pestizide**

Säule: LiChroCART 250-4  
LiChrospher 60 RP select B 5 µm  
Fluß: 0,8 ml/min  
Mobile Phase: A: Natriumacetat 0,5 mmol/l  
B: Acetonitril  
Gradient: 0 min 20 % B -> 20 min 28 % B  
const. bis 35 min -> 75 min 55 % B  
Temperatur: 22 °C  
Detektion: UV 215 nm  
Injektionsvol.: 100 µl

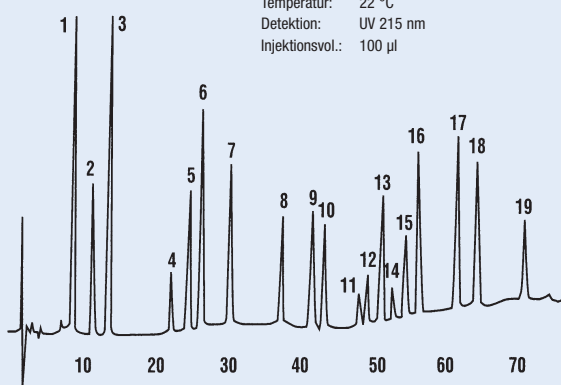

- |                       |                     |                 |
|-----------------------|---------------------|-----------------|
| 1 Desisopropylatrazin | 8 Metabenzthiazuron | 15 Metazachlor  |
| 2 Hydroxyatrazin      | 9 Atrazin           | 16 Sebutylazin  |
| 3 Desethylatrazin     | 10 Chlortoluron     | 17 Terbutylazin |
| 4 Hexazinon           | 11 Monolinuron      | 18 Linuron      |
| 5 Metoxuron           | 12 Isoproturon      | 19 Metolachlor  |
| 6 Simazin             | 13 Diuron           |                 |
| 7 Cyananazin          | 14 Metobromuron     |                 |

**LiChroCART®**

**Purospher®**

Best.-Nr.	Beschreibung	€
1.50237.0001	30 x 2 mm 3 µm STAR RP-18e (Satz)	392,00
1.50240.0001	55 x 2 mm 3 µm STAR RP-18e (Satz)	446,00
1.50234.7184	55 x 2 mm 3 µm STAR RP-18e	☞
1.50239.0001	30 x 4 mm 3 µm STAR RP-18e (Satz)	367,00
1.50225.0001	30 x 4 mm 3 µm STAR RP-18e (3 Stk.)	517,00
1.50242.0001	55 x 4 mm 3 µm STAR RP-18e (Satz)	411,00
1.50231.0001	55 x 4 mm 3 µm STAR RP-18e (3 Stk.)	586,00
1.51460.0001	75 x 4 mm 3 µm STAR RP-18e	277,00
1.50255.0001	125 x 2 mm 5 µm STAR RP-18e Li-CART	444,00
1.50256.0001	250 x 2 mm 5 µm STAR RP-18e Li-CART	477,00
1.50253.0001	125 x 3 mm 5 µm STAR RP-18e Li-CART	427,00
1.50254.0001	250 x 3 mm 5 µm STAR RP-18e Li-CART	497,00
1.50234.7220	55 x 2 mm 5 µm STAR RP-8e Li-CART	☞
1.50274.0001	125 x 2 mm 5 µm STAR RP-8e Li-CART	444,00
1.50275.0001	250 x 2 mm 5 µm STAR RP-8e Li-CART	476,00
1.50038.0001	125 x 3 mm 5 µm STAR RP-8e Li-CART	400,00
1.50273.0001	250 x 3 mm 5 µm STAR RP-8e Li-CART	497,00
1.50201.7127	10 x 2 mm 5 µm RP-18 Li-CART (3 Stk)	☞
1.50234.7127	55 x 2 mm 5 µm RP-18 Li-CART	☞
1.50195.7127	125 x 2 mm 5 µm RP-18 Li-CART	☞
1.50190.7127	250 x 2 mm 5 µm RP-18 Li-CART	☞
1.50236.7127	55 x 3 mm 5 µm RP-18 Li-CART	☞
1.50175.7127	125 x 3 mm 5 µm RP-18 Li-CART	☞
1.50177.7127	250 x 3 mm 5 µm RP-18 Li-CART	☞
1.50141.0001	4 x 4 mm 5 µm RP-18 (10 Stk.) Li-CART	258,00
1.50142.0001	125 x 4 mm 5 µm RP-18 Li-CART	476,00
1.50144.0001	250 x 4 mm 5 µm RP-18 Li-CART	528,00
1.51442.7127	125 x 4,6 mm 5 µm RP-18 Li-CART	☞
1.51432.7127	150 x 4,6 mm 5 µm RP-18 Li-CART	☞
1.51431.7127	250 x 4,6 mm 5 µm RP-18 Li-CART	☞
1.50178.7127	10 x 10 mm 5 µm RP-18 (2 Stk) Li-CART	☞
1.51446.7127	50 x 10 mm 5 µm RP-18 Li-CART	☞
1.51443.7127	125 x 10 mm 5 µm RP-18 Li-CART	☞
1.51444.7127	150 x 10 mm 5 µm RP-18 Li-CART	☞
1.50179.7127	250 x 10 mm 5 µm RP-18 Li-CART	☞
1.50201.7130	10 x 2 mm 5 µm RP-18e (3 Stk) Li-CART	☞
1.50234.7130	55 x 2 mm 5 µm RP-18e Li-CART	☞
1.50190.7130	250 x 2 mm 5 µm RP-18e Li-CART	☞
1.50236.7130	55 x 3 mm 5 µm RP-18e Li-CART	☞
1.50798.0001	125 x 3 mm 5 µm RP-18e Li-CART	432,00
1.51384.0001	250 x 3 mm 5 µm RP-18e Li-CART	530,00
1.50228.7130	55 x 4 mm 5 µm RP-18e Li-CART	☞
1.51442.7130	125 x 4,6 mm 5 µm RP-18e Li-CART	☞
1.51432.7130	150 x 4,6 mm 5 µm RP-18e Li-CART	☞
1.51431.7130	250 x 4,6 mm 5 µm RP-18e Li-CART	☞
1.50178.7130	10 x 10 mm 5 µm RP-18e (2 Stk) Li-CART	☞
1.51446.7130	50 x 10 mm 5 µm RP-18e Li-CART	☞
1.51443.7130	125 x 10 mm 5 µm RP-18e Li-CART	☞
1.51444.7130	150 x 10 mm 5 µm RP-18e Li-CART	☞
1.50179.7130	250 x 10 mm 5 µm RP-18e Li-CART	☞
1.50167.0001	4 x 4 mm 5 µm 120 RP-18e (10 Stk) Li-CART	258,00
1.50168.0001	125 x 4 mm 5 µm 120 RP-18e Li-CART	432,00
1.50169.0001	250 x 4 mm 5 µm 120 RP-18e Li-CART	485,00
1.50173.7131	4 x 4 mm 5 µm RP-18 HC Li-CART	☞
1.51431.7131	250 x 4,6 mm 5 µm RP-18 HC Li-CART	☞

**Hibar®**

**Purospher®**

Best.-Nr.	Beschreibung	€
1.51196.7130	30 x 4 mm 5 µm RP-18e	☞
1.50181.7130	125 x 4 mm 5 µm RP-18e	☞
1.50182.7130	250 x 4 mm 5 µm RP-18e	☞
1.50013.7130	100 x 4,6 mm 5 µm RP-18e	☞
1.50012.7130	125 x 4,6 mm 5 µm RP-18e	☞
1.50009.7130	150 x 4,6 mm 5 µm RP-18e	☞
1.00424.7130	250 x 4,6 mm 5 µm RP-18e	☞
1.50183.7130	250 x 10 mm 5 µm RP-18e	☞
1.51196.7127	30 x 4 mm 5 µm RP-18	☞
1.50181.7127	125 x 4 mm 5 µm RP-18	☞
1.50182.7127	250 x 4 mm 5 µm RP-18	☞
1.50013.7127	100 x 4,6 mm 5 µm RP-18	☞
1.50012.7127	125 x 4,6 mm 5 µm RP-18	☞
1.50009.7127	150 x 4,6 mm 5 µm RP-18	☞
1.00424.7127	250 x 4,6 mm 5 µm RP-18	☞
1.50183.7127	250 x 10 mm 5 µm RP-18	☞

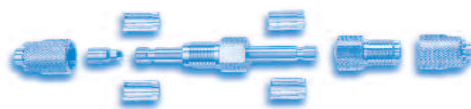

**LiChroCART®**

**Superspher®**

Best.-Nr.	Beschreibung	€
1.16054.0001	125 x 4 mm Si 60	422,00
1.16009.0001	250 x 4 mm Si 60	496,00
1.16052.0001	125 x 4 mm 60 RP-8	439,00
1.16010.0001	250 x 4 mm 60 RP-8	529,00
1.16854.0001	125 x 4 mm 60 RP-8 endcapped	439,00
1.16857.0001	250 x 4 mm 60 RP-8 endcapped	529,00
1.50205.0001	10 x 2 mm 60 RP-select B (3 Stk.)	140,00
1.50197.0001	125 x 2 mm 60 RP-select B	485,00
1.51308.0001	250 x 2 mm 60 RP-select B	574,00
1.50791.0001	125 x 3 mm 60 RP-select B	494,00
1.51288.0001	250 x 3 mm 60 RP-select B	530,00
1.50974.0001	75 x 4 mm 60 RP-select B (3 Stk.)	709,00
1.50975.0001	125 x 4 mm 60 RP-select B	494,00
1.50973.0001	250 x 4 mm 60 RP-select B	574,00
1.50204.0001	10 x 2 mm 100 RP-18 (3 Stk.)	140,00
1.16039.0001	25 x 4 mm 100 RP-18 (3 Stk.)	397,00
1.50980.0001	75 x 4 mm 100 RP-18 (3 Stk.)	635,00
1.50200.0001	125 x 2 mm 100 RP-18	485,00
1.50792.0001	125 x 3 mm 100 RP-18	464,00
1.16051.0001	125 x 4 mm 100 RP-18	439,00
1.51299.0001	250 x 3 mm 100 RP-18	530,00
1.16056.0001	250 x 4 mm 100 RP-18	529,00
1.16869.0001	25 x 4 mm 100 RP-18 endcapped (3 Stk.)	397,00
1.50198.0001	125 x 2 mm 100 RP-18 endcapped	485,00
1.50193.0001	250 x 2 mm 100 RP-18 endcapped	530,00
1.16855.0001	125 x 4 mm 100 RP-18 endcapped	439,00
1.16858.0001	250 x 4 mm 100 RP-18 endcapped	529,00

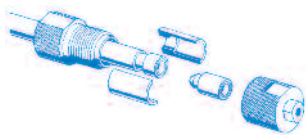

## Zubehör

### Hibar® RT Werkzeuge

Best.-Nr.	Beschreibung	€
1.51210.0001	Werkzeug z. Entf. von Fritten Ø 4 mm	52,60

### Hibar® RT Ersatzfritten

Best.-Nr.	Beschreibung	€
1.51211.0001	Ø 4 mm 3 Stk mit PTFE-Ringdichtungen	66,30
1.51220.0001	Ø 10 mm 3 Stk mit PTFE-Ringdichtungen	117,00

### Hibar® & LiChroCART® Kapillarrohre

Best.-Nr.	Beschreibung	€
1.51230.0001	80 x 0,25 mm ID/AD 1/16" (10 Stk)	127,00
1.51231.0001	120 x 0,25 mm ID/AD 1/16" (10 Stk)	136,00
1.15547.0001	250 x 0,2 mm ID/AD 0,5 mm (5 Stk) <i>flexible Edelstahlkapillaren</i>	73,00
1.51236.0001	1.000 x 0,2 mm ID/AD 0,5 mm (3 Stk) <i>flexible Edelstahlkapillaren</i>	147,00
1.51247.0001	150 x 0,1 mm ID/AD 0,5 mm (5 Stk) <i>Hibar® Kapillarrohr für die Mikro-HPLC</i>	88,00
1.51245.0001	1.000 x 0,1 mm ID/AD 0,5 mm (1 Stk) <i>Hibar® Kapillarrohr für die Mikro-HPLC</i>	79,30

### LiChroCART® Montagewerkzeug

Best.-Nr.	Beschreibung	€
1.15576.0001	Hibar® LiChroCART® Montagewerkzeug <i>1 Zentrierhülse, 1 Stempel, 1 Werkzeug zur Entfernung von PTFE-Dichtungen aus LiChroCART-Kartuschen</i>	29,20

### LiChroCART® manu-CART®

Best.-Nr.	Beschreibung	€
1.51486.0001	manu-CART NT Kartuschenhalter <i>f. LiChroCART® Kartuschen ID 2; 3; 4; 4,6 mm</i>	294,00
1.51419.0001	manu-CART '10'-II Verschraubung <i>2 kompl. Verschraubungen f. LiChroCART® Kartuschen ID 10 mm für Kapillarananschluß (AD 1/16" oder 0,5 mm)</i>	359,00
1.50226.0001	Halter f. LiChroCART 55-4 Kartuschen	183,00
1.50227.0001	Halter f. LiChroCART 30-4 Kartuschen	140,00
1.50082.0001	manu-CART '4' Kopplungseinheit für LiChroCART 25-4 Kartuschen	268,00
1.50017.0001	manu-CART '4' Kartuschenhalter für LiChroCART 25-4 Kartuschen	232,00
1.50083.0001	manu-CART '4' Kopplungsteil zum Koppeln von 2 LiChroCART HPLC-Kartuschen	103,00
1.51258.0001	Druckstück f. manu-CART '4' Verschraubung	110,00
1.51257.0001	Halbschalen f. " '4' Verschraubung	87,80

### Hibar® & LiChroCART® Starter Kit

Best.-Nr.	Beschreibung	€
1.13171.0001	HPLC Starter-Kit <i>4 Rändelschrauben für Kapillarananschluß (AD 1/16" oder 0,5 mm) 10 PVDF-Doppelkone für Kapillarananschluß (AD 0,5 mm, ID 0,2 mm); 10 Filter (Edelstahl) mit PTFE-Dichtring und 10 Keramik-Vliese für HPLC-Kartuschen LiChroCART (ID 4 mm); 3 Kopplungsteile; 6 Anpreßschrauben und 6 Klemmringe für Kapillaren (AD 1/16" oder 0,5 mm); je 1 Kapillarrohr (AD 1/16", 0,25 mm) der Länge 50, 80, 120 und 200 mm; 1 totvolumenfreies Kopplungsteil für Kapillaren (AD 1/16" oder 0,5 mm); 8 Anpreßschrauben für Kapillarananschluß und 10 Klemmringe für Kapillarananschluß (AD 1/16"); 3 Edelstahlkapillaren (AD 0,5 mm, ID 0,2 mm), Länge 1000 mm; 2 Langhals-rändelschrauben und 6 PVDF-Doppelkone für 6-Wege-Injektionsventile (Typ Rheodyne 7125); 10 PVDF-Doppelkone für Kapillarananschluß (AD 1/16")</i>	717,00
1.51193.0001	Inline Filterhalterung (Satz)	107,00
1.51192.0001	Inline Filter ADS PEEK (5 Stk)	143,00
1.51194.0001	Filtereinsatz Inline 2 µm (10 Stk)	79,60

### LiChroCART® Verschußelemente

Best.-Nr.	Beschreibung	€
1.51195.0001	Verschußelement PVDF 10 Stk.	76,40

### LiChroCART® manu-fix®

Best.-Nr.	Beschreibung	€
1.16333.0001	manu-fix Halter f. LiChroCART® 4-4 Vorsäulen <i>1 Halterung, zweiteilig, Edelstahl</i>	160,00

### Hibar® & LiChroCART® Zubehör

Best.-Nr.	Beschreibung	€
1.51214.0001	Montageset für Kapillarananschluß 1/16" <i>je 1 Kapillarrohr (AD 1/16"). ID 0,25 mm) der Längen 50, 80 120 &amp; 200 mm 1 totvolumenfreies Kopplungsteil für Kapillaren (AD 1/16") oder 0,5 mm 8 Anpreßschrauben für Kapillarananschluß (AD 1/16") 10 Klemmringe für Kapillarananschluß (AD 1/16")</i>	290,00
1.51213.0001	Kopplungsset (totvolumenfrei) für Kapillaren 1/16" oder 0,5 mm AD <i>3 Kopplungsteile, 6 Anpreßschrauben, 6 Klemmringe</i>	346,00
1.51252.0001	Kopplungsteil (totvolumenfrei) für Kapillaren 1/16" oder 0,5 mm AD (3 Stk)	202,00
1.51216.0001	Anpreßschrauben f. Kapillarananschluß 1/16" (10 Stk)	142,00
1.15545.0001	Hibar-Rändelschrauben f. Kapillarverbindungen 0,2 mm ID/AD 0,5 mm mit PVDF-Doppelkone (4 Stk)	140,00
1.51237.0001	Hibar-Rändelschrauben m. langem Hals und PVDF-Kone f. 6-Wege-Ventile (Rheodyne) <i>2 Rändelschrauben (Edelstahl), 6 PVDF-Doppelkone</i>	180,00
1.51217.0001	Schneidringe für Kapillarananschluß 1/16" <i>20 Klemmringe (Kegelwinkel 18°, Edelstahl)</i>	124,00
1.51238.0001	Hibar-PVDF-Doppelkone für Kapillarananschluß 1/16" mit Rändelschraube (10 Stk)	130,00
1.15546.0001	Hibar-PVDF-Doppelkone (10 Stk)	371,00
1.51218.0001	Verschußschrauben PVDF (20 Stk)	45,30
1.16217.0001	Vorsäulenhalterung für PVDF-Kartuschen 4-4	151,00